

## 3V-40V Vin, 300mA, Ultra-Low Quiescent Current LDO

### FEATURES

- Qualified for Automotive Applications
- AEC-Q100 Qualified with the Following Results:
  - Device Temperature Grade 1: -40°C to 125°C
- Wide Input Range: 3V-40V
- With up to 45V Transient Input Voltage
- Maximum Output Current: 300mA
- Output Voltage: 0.65V~25V
- Output Voltage Accuracy:
  - $T_J = 25^\circ\text{C} : \pm 1\%$
  - $T_J = -40^\circ\text{C} \sim 125^\circ\text{C} : \pm 2\%$
- Ultra-Low Quiescent Current: 2.5 $\mu\text{A}$
- Low Dropout Voltage :
  - 189mV at 150mA load current
- Support Output Capacitors Range:
  - 3.3 $\mu\text{F}$ ~220 $\mu\text{F}$
  - Low-ESR: 0.001 $\Omega$ ~ 5  $\Omega$
- 1ms Internal Soft-start Time
- Current Limit Protection with VIN\_HIGH Control
- Precision Enable Threshold for Programmable Input Voltage Under-Voltage Lock Out Protection (UVLO) Threshold and Hysteresis
- Over-Temperature Protection
- Available Package: EMSOP-8L

### APPLICATIONS

- Automotive Head Units
- Headlights
- Body Control Modules
- Inverter and Motor Controls

### DESCRIPTION

The SCT71403A05Q series products is a low-dropout linear regulator designed to operate with a wide input-voltage range from 3V to 40V and 300mA output current with enable control feature. The SCT71403A05Q series products is stable with 3.3 $\mu\text{F}$ ~220 $\mu\text{F}$  output capacitors, and 10 $\mu\text{F}$  ceramic capacitor is recommended.

Only 2.5 $\mu\text{A}$  typical quiescent current at light load makes the SCT71403A05Q series products ideal choices for portable devices with battery power supply and an optimal solution for powering microcontrollers (MCUs) and CAN/LIN transceivers in always-on systems.

The SCT71403A05Q series products integrated short-circuit and overcurrent protection with VIN\_HIGH Control feature, which makes the device more reliable during transient high-load current faults or shorting events.

The SCT71403A05Q series products provide adjustable output version which can adjust the output voltage from 0.65V to 25V.

The SCT7140Q series products is available in EMSOP-8L packages, for other package options, please contact SCT sales.

### TYPICAL APPLICATION

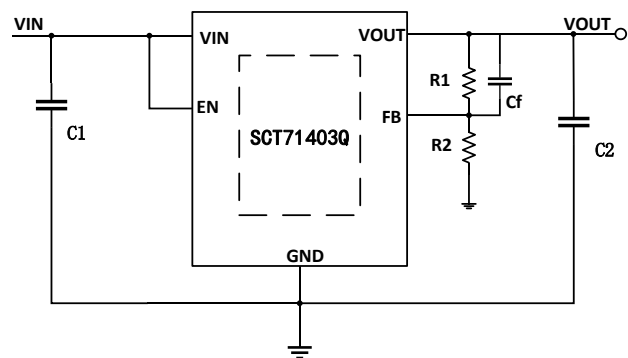

# SCT71403A05Q Series

## REVISION HISTORY

NOTE: Page numbers for previous revisions may differ from page numbers in the current version.

Revision 1.0: Release to production.

Revision 1.1: Updated the POD with tolerances and the curve of thermal characteristics.

## DEVICE ORDER INFORMATION

Orderable Device	Output Voltage	Package	Package Marking	PINS	MSL	Transport Media, Quantity
SCT71403A05QMTER	Adjustable	EMSOP-8L	3A05Q	8	2	Tape & Reel, 4000

## PIN CONFIGURATION

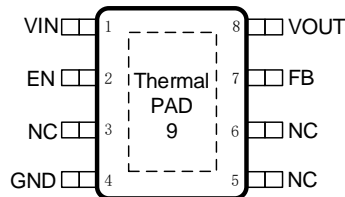

**SCT71403A05QMTER**  
EMSOP-8L Package

## PIN FUNCTIONS

NAME	PIN FUNCTION	
	EMSOP-8L	
VOUT	8	Regulated output voltage pin.
NC	3,5,6	No connection.
GND	4	Ground reference pin.
VIN	1	Input voltage pin.
EN	2	Enable input pin.
FB	7	Feedback Input for Output Adjustable Version.
Thermal Pad	9	Connect the thermal pad to a large area GND plane for improved thermal performance.

## RECOMMENDED OPERATING CONDITIONS

Over operating free-air temperature range unless otherwise noted

PARAMETER	DEFINITION	MIN	MAX	UNIT
$V_{IN}$	Input voltage range	3	40	V
$V_{OUT}$	Adjustable Output Version	0.65	25	V
$V_{EN}$	Enable input voltage	0	$V_{IN}$	V
$C_{IN}$	Input capacitor	2.2	--	uF
$C_{OUT}$	Output capacitor	3.3	220	uF
ESR	Output capacitor ESR requirements	0.001	5	$\Omega$
$T_A$	Operating ambient temperature	-40	125	$^{\circ}\text{C}$

T <sub>J</sub>	Operating junction temperature	-40	125	°C
----------------	--------------------------------	-----	-----	----

## ABSOLUTE MAXIMUM RATINGS

Over operating free-air temperature range unless otherwise noted <sup>(1)</sup>

PARAMETER	DEFINITION	MIN	MAX	UNIT
V <sub>IN</sub>	Maximum input voltage range	-0.3	45	V
V <sub>OUT</sub>	Maximum output voltage range	-0.3	25	V
V <sub>EN</sub>	Maximum enable input voltage	-0.3	V <sub>IN</sub>	V
V <sub>FB</sub>	Maximum feedback pin voltage	-0.3	5.5	V
T <sub>J</sub> <sup>(2)</sup>	Junction temperature range	-40	150	°C
T <sub>stg</sub>	Storage temperature range	-65	150	°C

- (1) Stresses beyond those listed under Absolute Maximum Rating may cause device permanent damage. The device is not guaranteed to function outside of its Recommended Operation Conditions.
- (2) The IC includes over temperature protection to protect the device during overload conditions. Junction temperature will exceed 150°C when over temperature protection is active. Continuous operation above the specified maximum operating junction temperature will reduce lifetime.

## ESD RATINGS

PARAMETER	DEFINITION	MIN	MAX	UNIT
V <sub>ESD</sub>	Human Body Model(HBM), per ANSI-JEDEC-JS-001-2014 specification, all pins <sup>(1)</sup>	-5	+5	kV
	Charged Device Model(CDM), per ANSI-JEDEC-JS-002-2014 specification, all pins <sup>(2)</sup>	-2	+2	kV

- (1) JEDEC document JEP155 states that 500V HBM allows safe manufacturing with a standard ESD control process.
- (2) JEDEC document JEP157 states that 250V CDM allows safe manufacturing with a standard ESD control process.

# SCT71403A05Q Series

## THERMAL INFORMATION

The value of  $R_{\theta JA}$  and  $R_{\theta JC}$  given in this table is only valid for comparison with other packages and cannot be used for design purposes. Because they were simulated in accordance with JESD 51-7. They do not represent the performance obtained in an actual application. For design information see Power Dissipation and Thermal Performance section.

The value of  $R_{\theta JA\_EVM}$  is the tested results based on our EVM, and is more useful for thermal design. Even if it still do not represent the thermal performance of customer's PCB design, but it was a good starting point for thermal performance design.

The PCB information of our EVM: 4-layer, both the inner and outer layers are 1oz Cu, 50mm x 30mm size.

The values given in this table are not a characteristic of package itself, but of many other system level characteristics such as the design and layout of the printed circuit board (PCB), thermal pad size, and external environmental factors. The PCB board is a heat sink that is soldered to the leads and thermal pad of the device. Changing the design or configuration of the PCB board changes the efficiency of the heat sink and therefore the actual values of the below table.

PARAMETER (4-layer)	THERMAL METRIC	EMSOP-8L	UNIT
$R_{\theta JA}$	Junction to ambient thermal resistance	59.94	°C/W
$\Psi_{JT}$	Junction-to-top characterization parameter	6.81	
$\Psi_{JB}$	Junction-to-board characterization parameter	15.65	
$R_{\theta JCtop}$	Junction to case thermal resistance	36.08	
$R_{\theta JA\_EVM}$	junction to ambient thermal resistance	43.65	

- (1)  $R_{\theta JA}$  is junction to ambient thermal resistance, based on JESD51-7.
- (2)  $R_{\theta JC}$  is junction to case thermal resistance, based on JESD51-7.
- (3)  $R_{\theta JA\_EVM}$  is junction to ambient thermal resistance, which is tested on SCT EVM.

## ELECTRICAL CHARACTERISTICS

$V_{IN}=V_{OUT}+1V$ ,  $C_{OUT}=10\mu F$ ,  $T_J=-40^{\circ}C\sim 125^{\circ}C$ , typical value is tested under  $25^{\circ}C$ .

SYMBOL	PARAMETER	TEST CONDITION	MIN	TYP	MAX	UNIT
<b>Power Supply</b>						
$V_{IN}$	Operating input voltage		3		40	V
$V_{UVLO}$	$V_{IN}$ UVLO Threshold Hysteresis	$V_{IN}$ rising		2.54 60	2.7	V mV
$I_{SHDN}$	Shutdown current from $V_{IN}$ pin	$EN=0$ , $V_{OUT}=3.3V$ , $V_{IN}=4.3V$ , $T_J=25^{\circ}C$		0.29	0.6	$\mu A$
		$EN=0$ , $V_{OUT}=3.3V$ , $V_{IN}=4.3V$ , $T_J=-40^{\circ}C\sim 125^{\circ}C$			1	$\mu A$
		$EN=0$ , $V_{OUT}=3.3V/5V$ , $V_{IN}=12V$ , $T_J=25^{\circ}C$		0.7	1.1	$\mu A$
		$EN=0$ , $V_{OUT}=3.3V/5V$ , $V_{IN}=12V$ , $T_J=-40^{\circ}C\sim 125^{\circ}C$				1.85
$I_Q$	Quiescent current from GND pin	$EN$ float, no load, $V_{IN}=V_{OUT}+1V$ (not include $I_{FB}$ ), $T_J=25^{\circ}C$		2.5	3.6	$\mu A$
		$EN$ float, no load, $V_{IN}=V_{OUT}+1V$ (not include $I_{FB}$ ), $T_J=-40^{\circ}C\sim 125^{\circ}C$			4.9	$\mu A$
		$EN$ float, no load, $V_{IN}=12V$ (not include $I_{FB}$ ), $T_J=25^{\circ}C$		3.2	4.8	$\mu A$
		$EN$ float, no load, $V_{IN}=12V$ (not include $I_{FB}$ ), $T_J=-40^{\circ}C\sim 125^{\circ}C$				5.5

### Regulated Output Voltage and Current

$\Delta V_{OUT}$	Line regulation	$V_{IN}=V_{OUT}+1V$ to 40V, $I_{OUT}=1mA$ , $V_{OUT}=3.3V$		1	10	mV
	Load regulation	$I_{OUT}=1mA$ to 300mA, $V_{OUT}=3.3V$		10	20	mV
$V_{REF}$	Reference voltage of FB	$T_J=25^{\circ}C$	0.6435	0.65	0.6565	V
		$T_J=-40^{\circ}C\sim 125^{\circ}C$	0.637	0.65	0.663	V
$V_{DROP}$	Dropout voltage <sup>(1)</sup>	$V_{IN}=V_{OUT}-0.1V$ , $I_{OUT}=100mA$		117		mV
		$V_{IN}=V_{OUT}-0.1V$ , $I_{OUT}=150mA$		189		mV
$I_{OUT}$	Output current	$V_{OUT}$ in regulation	0		300	mA
$I_{SC\_VINLOW}$	Short current limit	$V_{OUT}=0V$ , $V_{IN}<30V$ , $T_J=25^{\circ}C$	340	400	510	mA
$I_{SC\_VINHIGH}$	Short current limit	$V_{OUT}=0V$ , $V_{IN}>30V$	150	240	330	mA
PSRR	Power supply rejection ratio <sup>(2)</sup>	$I_{OUT}=10mA$ , $f=1kHz$ , $C_{OUT}=10\mu F$		59		dB
		$I_{OUT}=10mA$ , $f=10kHz$ , $C_{OUT}=10\mu F$		36		dB
		$I_{OUT}=10mA$ , $f=100kHz$ , $C_{OUT}=10\mu F$		43		dB

### Enable and Soft-startup

$V_{EN\_H}$	Enable high threshold			1.5	1.7	V
$V_{EN\_L}$	Enable low threshold		1.1	1.26		V
$V_{EN\_Hys}$	Enable threshold hysteresis			240		mV

# SCT71403A05Q Series

SYMBOL	PARAMETER	TEST CONDITION	MIN	TYP	MAX	UNIT
I <sub>EN_0V</sub>	Enable pin pull-up current	EN=0V		0.3	0.6	μA
T <sub>SS</sub>	Soft-start time	Cf=1nF	0.4	1	2.6	mS
<b>Thermal Protection</b>						
T <sub>SD</sub>	Thermal shutdown threshold <sup>(3)</sup>	T <sub>J</sub> rising Hysteresis		175 12		°C °C

- (1) The dropout voltage is defined as  $V_{IN}-V_{OUT}$ , when force  $V_{IN}$  is 100mV below the value of  $V_{OUT}$  for  $V_{IN}=V_{OUT(NOM)}+1V$ .
- (2) PSRR is derived from bench characterization, not production test.
- (3) Thermal shutdown threshold is derived from bench characterization, not production test.

## TYPICAL CHARACTERISTICS

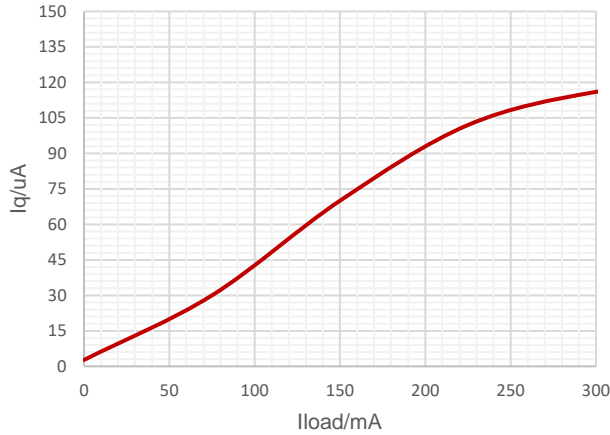

Figure 1. Quiescent Current vs Output Current

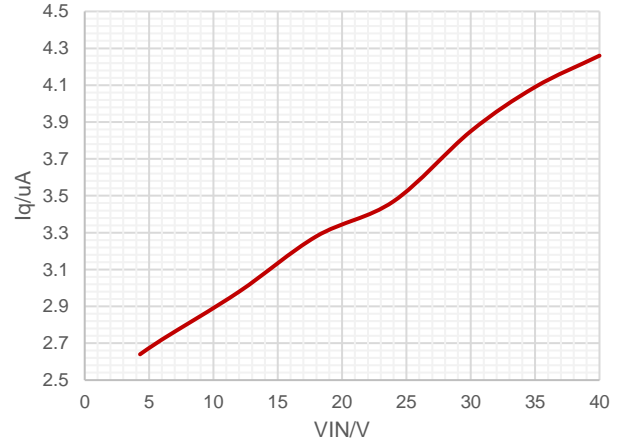

Figure 2. Quiescent Current vs Input Voltage, No load

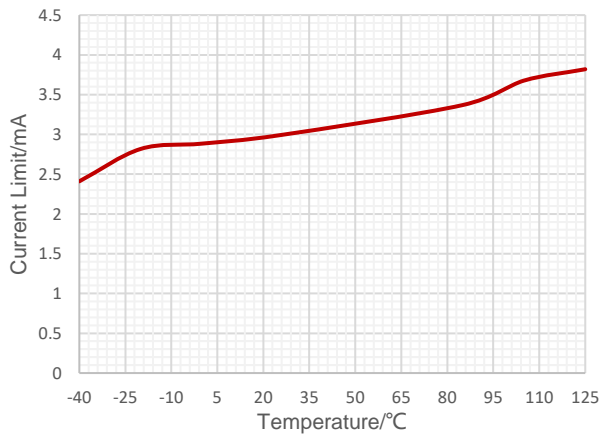

Figure 3. Quiescent Current vs Ambient Temperature

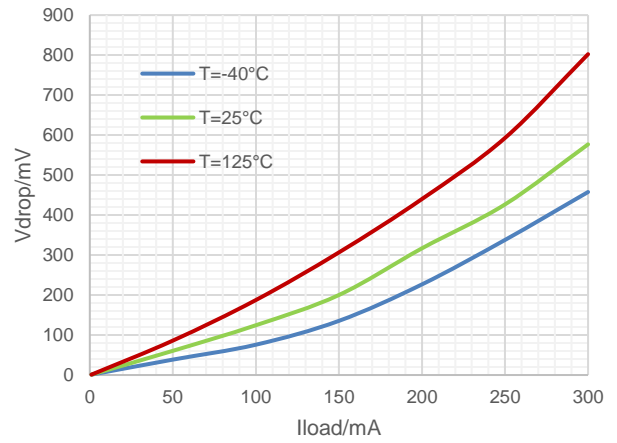

Figure 4. Dropout Voltage vs Output Current

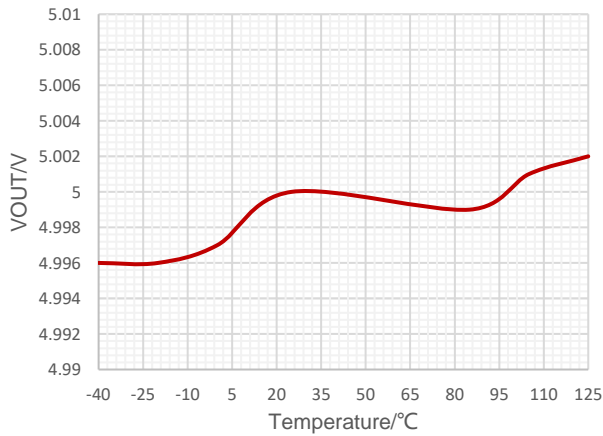

Figure 5. Output Voltage vs Ambient Temperature at VOUT=5V

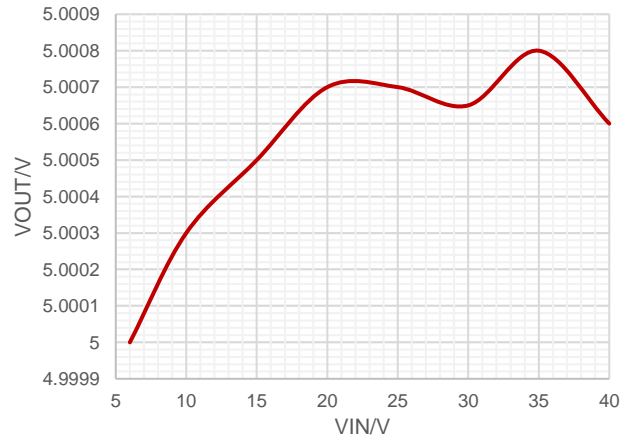

Figure 6. Output Voltage vs Input Voltage

# SCT71403A05Q Series

## TYPICAL CHARACTERISTICS (continued)

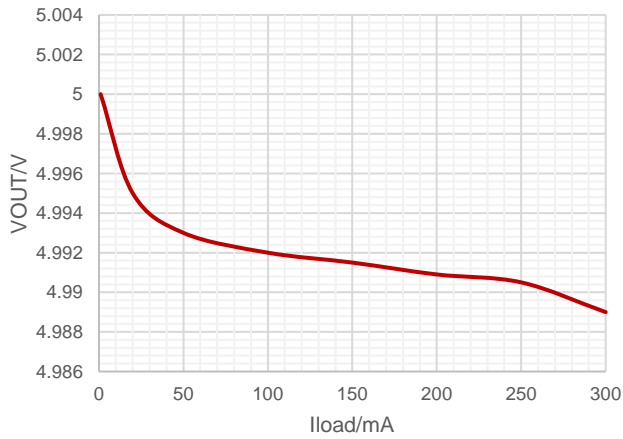

Figure 7. Output Voltage vs Output Current

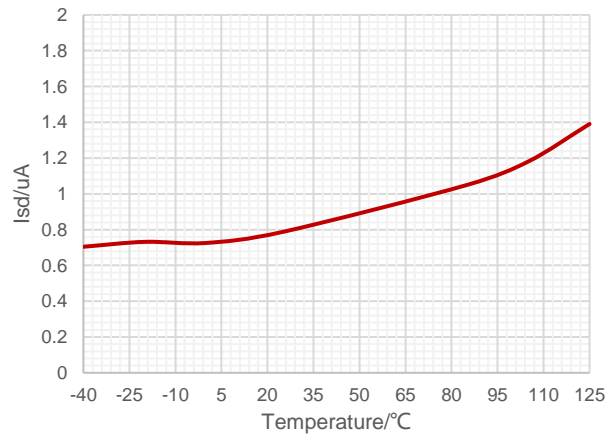

Figure 8. Shutdown Current vs Ambient Temperature

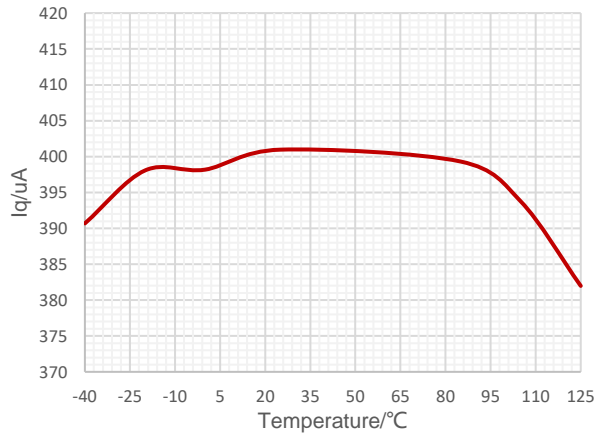

Figure 9. Output Current Limit vs Ambient Temperature at  $V_{IN} < 30V$

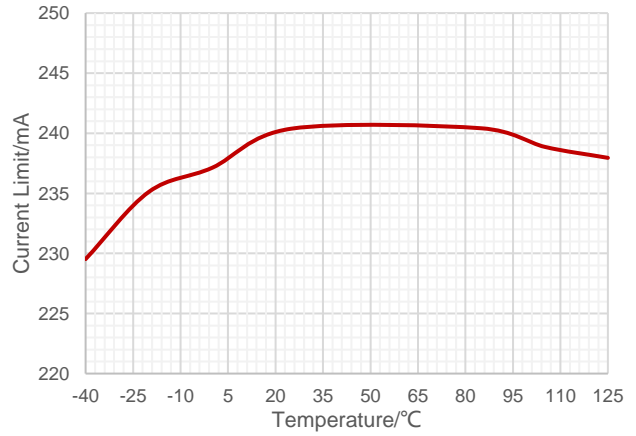

Figure 10. Output Current Limit vs Ambient Temperature at  $V_{IN} \geq 30V$

## TYPICAL CHARACTERISTICS (continued)

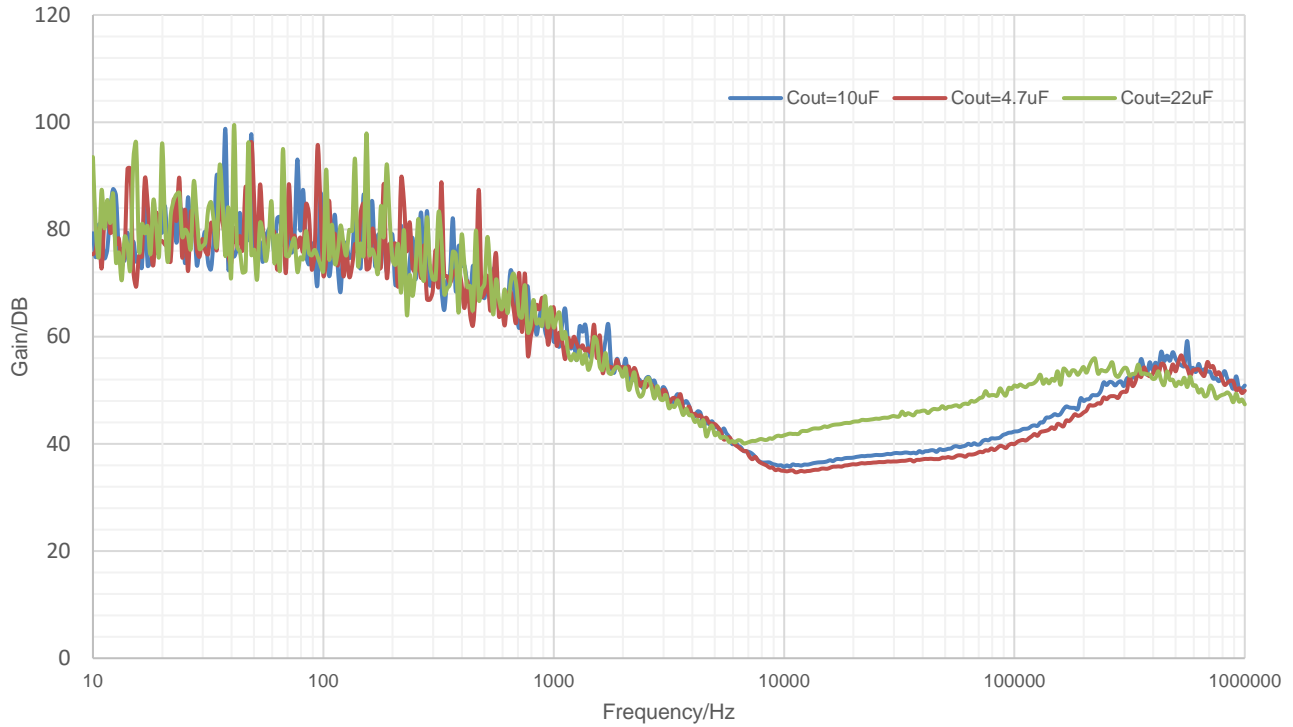

Figure 11. PSRR vs Frequency  
VIN=12V, VOUT=5V, Cf=10pF, IOUT=10mA

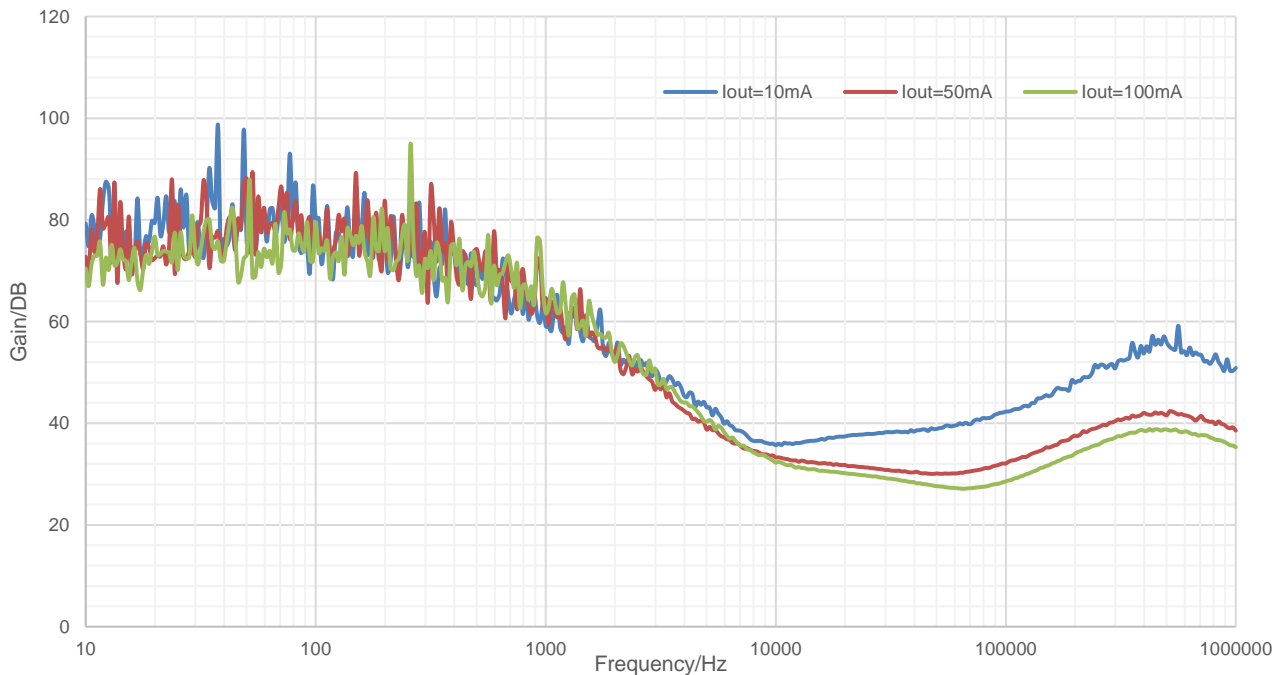

Figure 12. PSRR vs Frequency  
VIN=12V, VOUT=5V, Cf=10pF, COUT=10uF

# SCT71403A05Q Series

## FUNCTIONAL BLOCK DIAGRAM

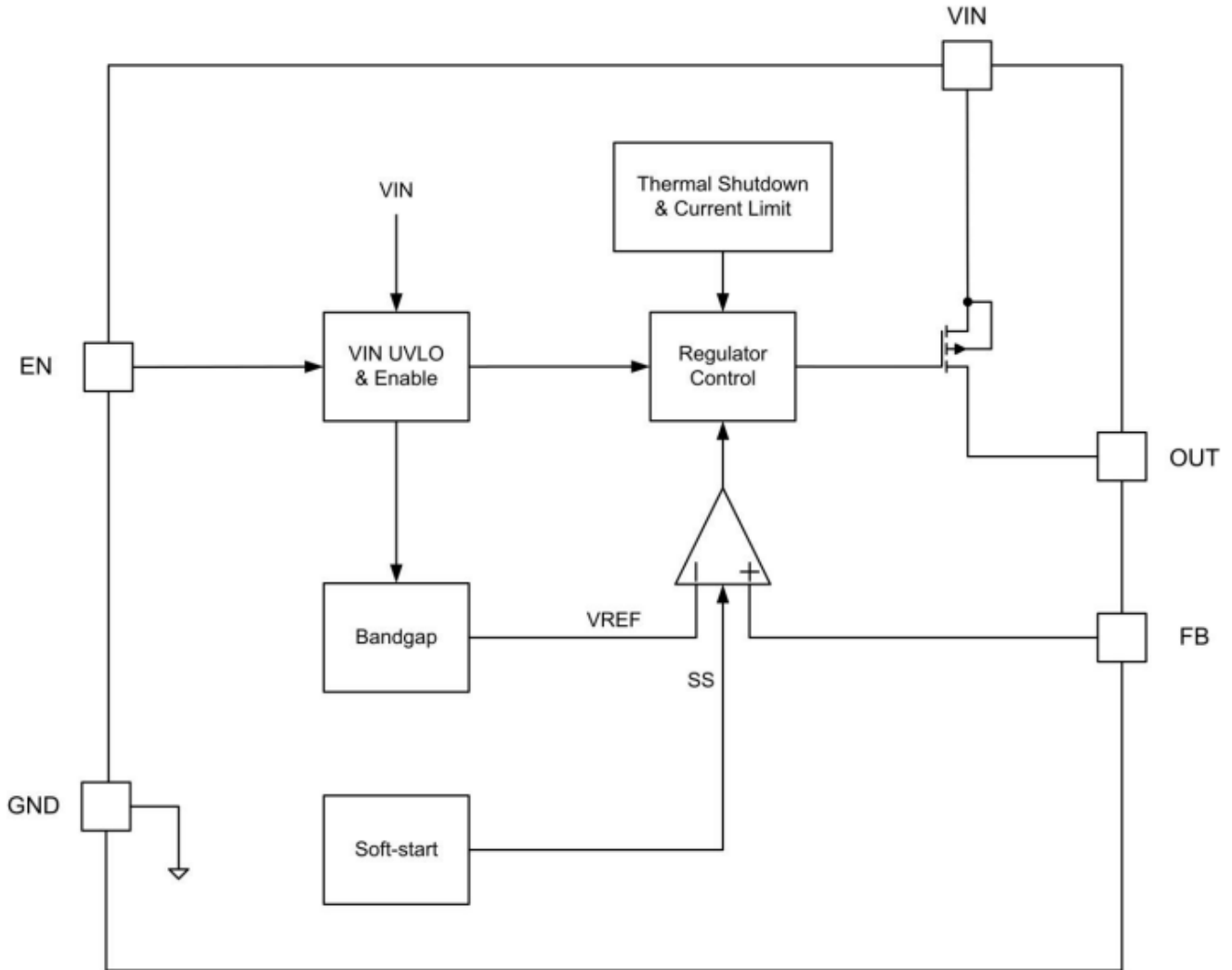

Figure 13. Functional Block Diagram

## OPERATION

### Overview

The SCT71403A05Q series products are 300mA wide input voltage range linear regulators with very low quiescent current. These voltage regulators operate from 3V to 40V DC input voltage with supporting 45V transient input voltage and consume 2.5µA quiescent current at no load.

The SCT71403A05Q series products is stable with 3.3µF~220µF output capacitors, and 10µF ceramic capacitor is recommended. An internal 1ms soft-start time avoids large inrush current and output voltage overshoot during startup.

The SCT71403A05Q series products also provide enable control. Other protection features include the VIN input under-voltage lockout, over current protection, output hard short protection and thermal shutdown protection.

The SCT71403A05Q series products provide adjustable output version which can adjust the output voltage from 0.65V to 25V. If you need a new output voltage version or a new package option, please feel free to contact SCT sales.

### Enable and Under Voltage Lockout Threshold

The SCT71403A05Q series products is enabled when the VIN pin voltage rises above 2.54V and the EN pin voltage exceeds the enable threshold  $V_{EN\_H}$ . The device is disabled when the VIN pin voltage falls below 2.54V or when the EN pin voltage is below  $V_{EN\_L}$ . Internal pull up current source to EN pin allows the device enable when EN pin floats.

For a higher system UVLO threshold, connect an external resistor divider (R1 and R2) from VIN to GND shown in Figure 18. The UVLO rising and falling threshold can be calculated by Equation 1 and Equation 2 respectively.

$$VIN_{rise} = V_{EN\_H} * \frac{R1 + R2}{R2} \quad (1)$$

$$VIN_{hys} = (V_{EN\_H} - V_{EN\_L}) * \frac{R1 + R2}{R2} \quad (2)$$

Where

$VIN_{rise}$ : Vin rise threshold to enable the device

$VIN_{hys}$ : Vin hysteresis threshold

$I_1=0.3\mu A$  and could be neglected in the calculation

$V_{EN\_H}=1.5V$

$V_{EN\_L}=1.26V$

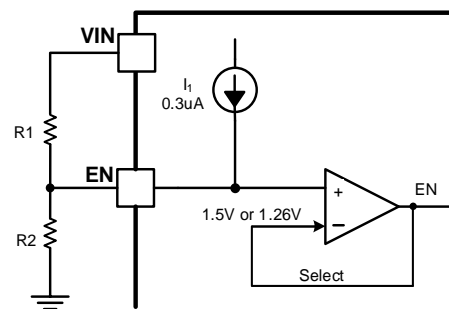

Figure 14. System UVLO by enable divide

### Regulated Output Voltage

The SCT71403A05Q series products provide adjustable output version which can adjust the output voltage from 0.65V to 25V. When the input voltage is higher than  $V_{OUT(NOM)}+V_{DROD}$ , output pin is the regulated output. When the input voltage falls below  $V_{OUT(NOM)}+V_{DROD}$ , output pin tracks the input voltage minus the dropout voltage based on the load current. When the input voltage drops below UVLO threshold, the output keeps shut off. Please feel free to contact SCT sales, if you need a new output voltage version or a new package option.

### Over Current Limit and Foldback Current Limit

The SCT71403A05Q series products has an internal current limit circuit that protects the regulator during transient high-load current faults or shorting events. The current limit is 400mA when  $VIN<30V$ , but SCT71403A05Q supplies a fold-back current limit 240mA when  $VIN>30V$ .

# SCT71403A05Q Series

The output voltage is not regulated when the device is in current limit. When a current limit event occurs, the regulator begins to heat up because of the increase in power dissipation. If thermal shutdown is triggered, the device turns off. After the device cools down, the internal thermal shutdown circuit turns the device back on. If the output current fault condition persists, the device cycles between current limit and thermal shutdown.

With the over current VIN\_HIGH Control feature, the SCT71403A05Q series products would be more robust and safer when over current faults and shorting events occur. But it also requires the maximum loading current should be smaller than I<sub>sc</sub> during startup. The characteristic is shown in the following figure.

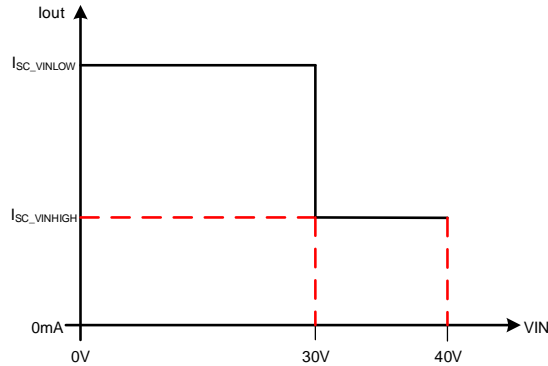

Figure 15. Current Limit with Foldback Feature

## Internal Soft-Start

The SCT71403A05Q series products integrates an internal soft-start circuit that ramps the reference voltage from zero volts to 0.65V reference voltage in 1ms. If the EN pin is pulled below 1.26V, LDO will be shut off and the internal soft-start resets. The soft-start also resets during shutdown due to thermal overloading.

Below figure shows the startup waveform at small output capacitor and large output capacitor. When output capacitor is small, for example 10uF, the slope of V<sub>OUT</sub> is limit by soft-start. When output capacitor is large, for example 100uF, the slope of V<sub>OUT</sub> is limited by current limit (I<sub>sc\_VINLOW</sub>) at VIN < 30V, and the slope of V<sub>OUT</sub> is limited by current limit (I<sub>sc\_VINHIGH</sub>), when VIN > 30V.

In SCT71403A05Q series products, typical T<sub>ss</sub> is 1ms, and typical I<sub>sc\_VINLOW</sub> is 400mA and typical I<sub>sc\_VINHIGH</sub> is 240mA, could use the following formula for initial startup time calculation.

$$T_{start} = \max \left\{ \frac{C_{OUT} \times V_{OUT}}{(I_{sc} - I_{load})}, T_{SS} \right\} \quad (3)$$

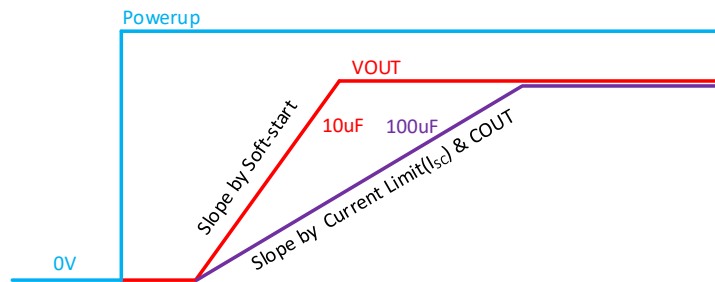

Figure 16. Soft-start Waveform vs Output Capacitor

## Thermal Shutdown

This device incorporates a thermal shutdown (T<sub>SD</sub>) circuit as a protection from overheating. For continuous normal operation, the junction temperature should not exceed the T<sub>SD</sub> trip point. The junction temperature exceeding the T<sub>SD</sub> trip point causes the output to turn off. When the junction temperature falls below the T<sub>SD</sub> trip point minus thermal shutdown hysteresis, the output turns on again.

## APPLICATION INFORMATION

### Typical application 1:

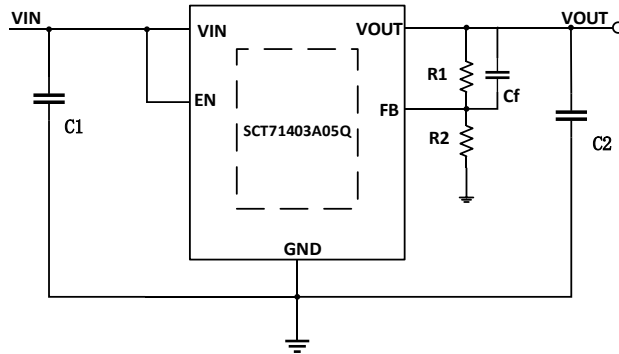

Figure 17. SCT71403A05Q Typical Application Schematic

### Design Parameters

Design Parameters	Example Value
Input Voltage	12V Normal, 3V~40V
Output Voltage	5V Normal, 0.65V~25V
Maximum Output Current	300mA
Output Capacitor Range (C <sub>2</sub> )	3.3uF~220uF , recommends 10uF
Input Capacitor Range (C <sub>1</sub> )	>2.2uF , recommends 10uF

### Typical application 2:

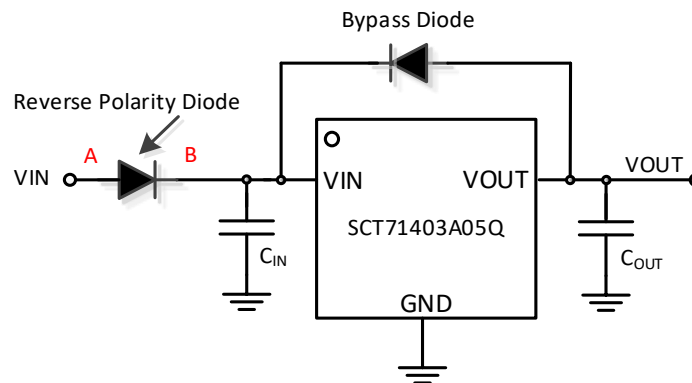

Figure 18. SCT71403A05Q Typical Application Schematic with Reverse Polarity Diode

### Design Parameters

Design Parameters	Example Value
Input Voltage	12V Normal, 3V~40V

# SCT71403A05Q Series

Output Voltage	5V Normal, 0.65V~25V
Maximum Output Current	300mA
Output Capacitor Range ( $C_{OUT}$ )	3.3uF~220uF , recommends 10uF
Input Capacitor Range ( $C_{IN}$ )	>2.2uF , recommends 10uF

In some applications, the VIN and the VOUT potential might be reversed, possibly resulting in circuit internal damage or damage to the elements. For example, the accumulated charge in the output pin capacitor flowing backward from the VOUT to the VIN when the VIN shorts to the GND. In order to minimize the damage in such case, use a capacitor with a capacitance less than 220 $\mu$ F. Also by inserting a reverse polarity diode in series to the VIN, it can prevent reverse current from reverse battery connection or the case, when the point A is short-circuited GND. If there may be any possible case point B is short-circuited to GND, we also recommend using a bypass diode between the VIN and the VOUT.

### Typical application 3:

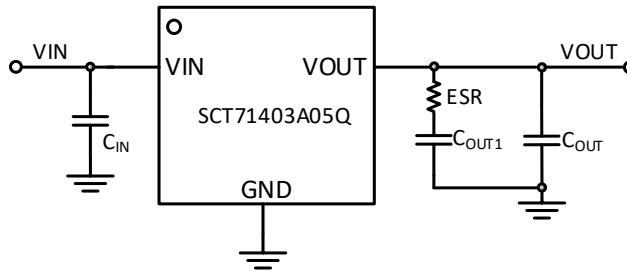

Figure 19. SCT71403A05Q Typical Application Schematic with Large Output Capacitor

### Design Parameters

Design Parameters	Example Value
Input Voltage	12V Normal, 3V~40V
Output Voltage	5V Normal, 0.65V~25V
Maximum Output Current	300mA
Output Capacitor Range ( $C_{OUT1}$ and ESR)	3.3uF~220uF with ESR=0.5 $\Omega$ ~5 $\Omega$
Output Capacitor Range ( $C_{OUT2}$ )	recommends 10uF with low ESR
Input Capacitor Range ( $C_{IN}$ )	>2.2uF , recommends 10uF

## Output Voltage

For adjustable output version the output voltage is set by an external resistor divider R1 and R2 in typical application schematic. Recommended R2 resistance is 100KΩ. Use equation 4 to calculate R1.

$$R_1 = \left( \frac{V_{OUT}}{V_{REF}} - 1 \right) * R_2 \quad (4)$$

where:

- $V_{REF}$  is the feedback reference voltage, typical 0.65V

**Table 1: Compensation Values for Typical Output Voltage/Capacitor Combinations**

Vout/V	COU <u>T</u> /uF	Cf	R1/KΩ	R2/KΩ	COU <u>T</u> 1/uF (optional)	ESR/Ω
1.8	10	33pF	178	100	220	1
2.5	10	33pF	287	100	220	1
3.3	10	33pF	412	100	220	1
5	10	33pF	665	100	220	1
18	10	1~10nF	26.7	1	220	1
23	10	1~10nF	34.8	1	220	1

## Input Capacitor and Output Capacitor

SCT recommends adding a 2.2μF or greater capacitor with a 0.1μF bypass capacitor in parallel at VIN pin to keep the input voltage stable. Aluminum electrolytic capacitor or other capacitor with high capacitance is suggested for the system power with large voltage spike. The voltage rating of the capacitors must be greater than the maximum input voltage

To ensure loop stability, the SCT71403A05Q series products requires an output capacitor with a minimum effective capacitance value of 3.3μF. And the series products could support output capacitor range from 3.3uF to 220uF and with an ESR range between 0.001Ω and 5Ω. SCT recommends selecting a X5R- or X7R-type 4.7uF~10uF ceramic capacitor with low ESR over temperature range to improve the load transient response.

When using large output capacitor with higher ESR resistor, for example 100uF output electrolytic capacitor with 1Ω ESR resistor in the application, SCT recommends adding extra 10uF low ESR output capacitor parallel connection with the large electrolytic capacitor, this will eliminate the undershoot/overshoot voltage caused by the large ESR resistor and get better load transient performance.

# SCT71403A05Q Series

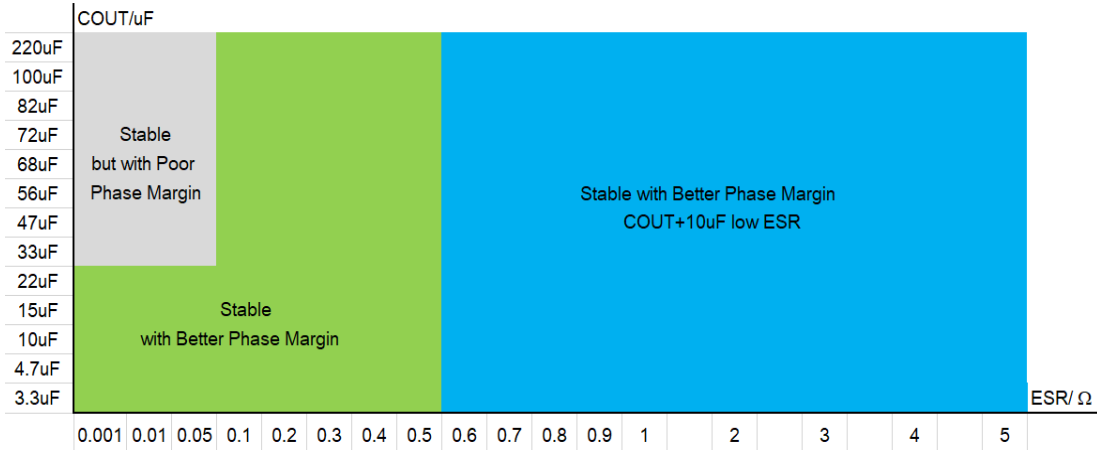

Figure 20. SCT71403A05Q Stability VS Output Capacitor

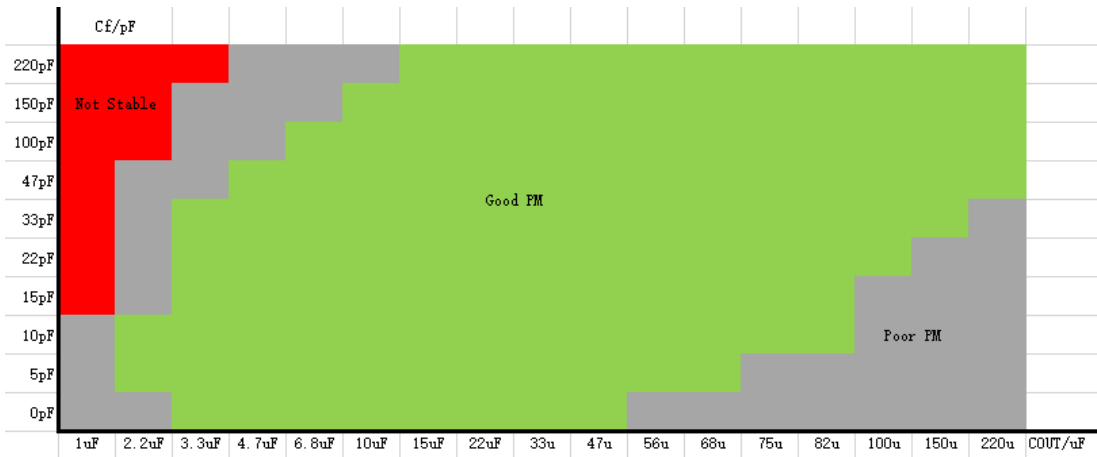

Figure 21. SCT71403A05Q Feed Forward Capacitors recommend( $R_2=100\text{k}\Omega$ ,  $V_{OUT}=3.3\text{V}$ )

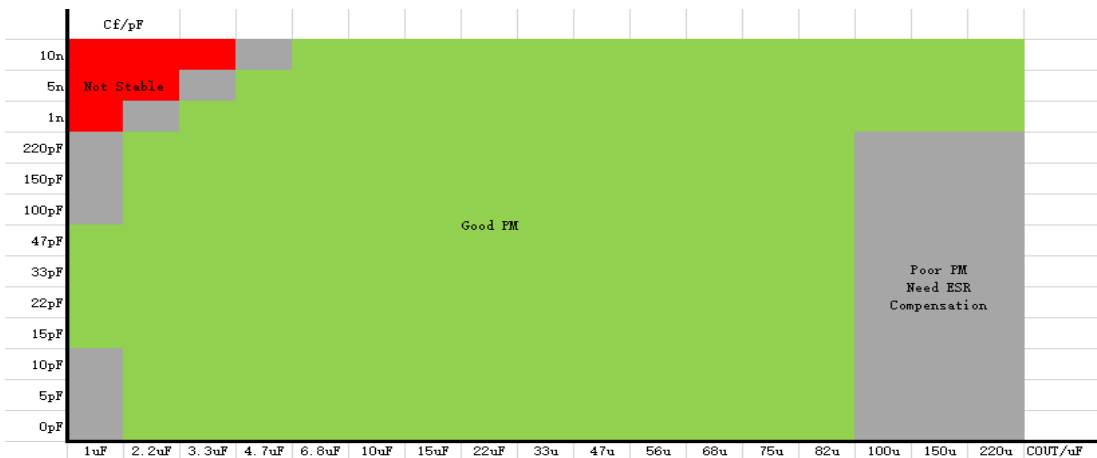

Figure 22. SCT71403A05Q Feed Forward Capacitors recommend( $R_2=1\text{k}\Omega$ ,  $V_{OUT}=18\text{V}$ )

## Power Dissipation and Thermal Performance

Power dissipation caused by voltage drop across the LDO and by the output current flowing through the device needs to be dissipated out from the chip. The maximum junction temperature is dependent on power dissipation, package, the PCB layout, number of used Cu layers, Cu layer thickness and the ambient temperature.

During normal operation, LDO junction temperature should not exceed 150°C, or else it may result in deterioration of the properties of the chip. Using below equations to calculate the power dissipation and estimate the junction temperature.

The power dissipation can be calculated using Equation 5. Because  $I_{GND} \ll I_{OUT}$ , the term  $V_{IN} \times I_{GND}$  in Equation 5 could be ignored.

$$P_D = (V_{IN} - V_{OUT}) \times I_{OUT} + V_{IN} \times I_{GND} \quad (5)$$

The junction temperature can be estimated using Equation 6.  $R_{\theta JA\_EVM}$  is the junction-to-ambient thermal resistance based on customer's PCB. Verify the application and allow sufficient margins in the thermal design by the following method is used to calculate the junction temperature  $T_J$ .

$$T_J = T_A + P_D \times R_{\theta JA\_EVM} \quad (6)$$

$R_{\theta JA\_EVM}$  is a critical parameter and depends on many factors such as the following:

- Power dissipation
- Air temperature/flow
- PCB area
- Copper heat-sink area
- Number of thermal vias under the package
- Adjacent component placement

For the SCT71403A05Q series products, the maximum allowable power dissipation of different packages was listed in the following table, and the test results are based on our EVM board, larger power dissipation will trigger thermal shutdown protection. As a result, we could calculate the  $R_{\theta JA\_EVM}$  of different packages. The following table is just for your reference based on our EVM test, please leave enough margin when you design thermal performance.

The PCB information of our EVM: 4-layer, both the inner and outer layers are 1oz Cu, 50mm x 30mm size.

**Thermal Performance of Different Packages Based on EVM Test**

Package	Max Allowable PD (W) (Not Trigger TSD, VOUT=5V)	Max Allowable PD (W) (T <sub>J</sub> ≤125°C)	R <sub>θJA_EVM</sub> (°C/W)
EMSOP-8L	3.436	2.291	43.65

# SCT71403A05Q Series

## THERMAL CHARACTERISTICS

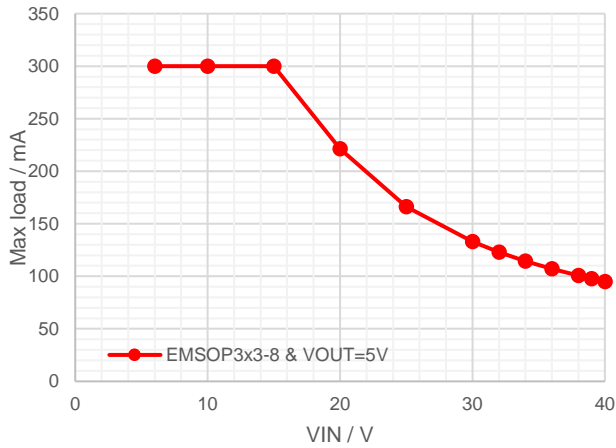

Figure 23. Maximum Output Current vs Input Voltage, VOUT=5V of EMSOP-8L,  $T_J \leq T_{SD\_R}$

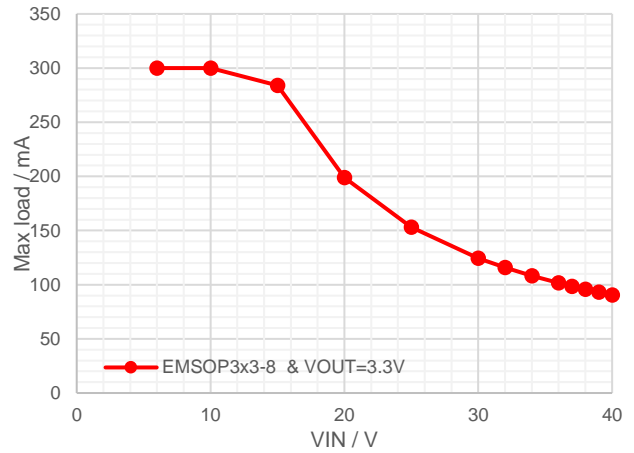

Figure 24. Maximum Output Current vs Input Voltage, VOUT=3.3V of EMSOP-8L,  $T_J \leq T_{SD\_R}$

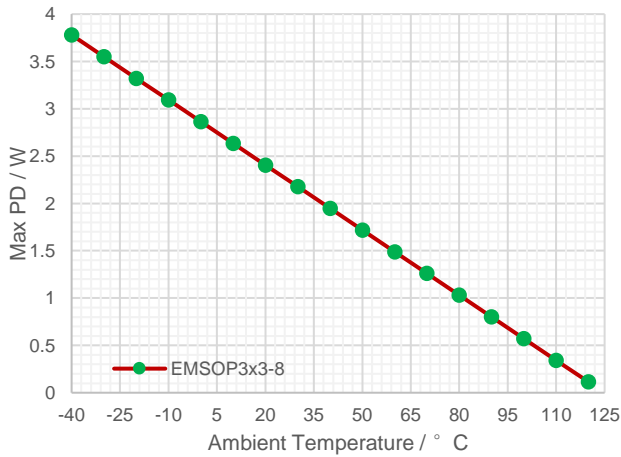

Figure 25. Maximum Allowed Power Dissipation vs Ambient Temperature, EMSOP-8L,  $T_J \leq 125^\circ\text{C}$

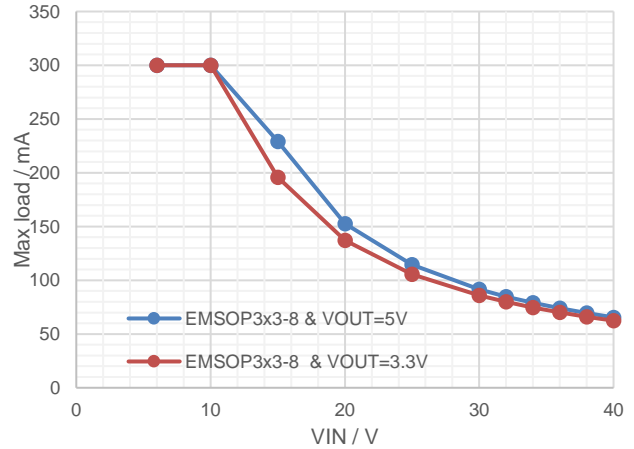

Figure 26. Maximum Output Current vs Input Voltage, EMSOP-8L,  $T_J \leq 125^\circ\text{C}$

## Application Waveforms

$V_{in} = V_{out} + 1V$ , unless otherwise noted

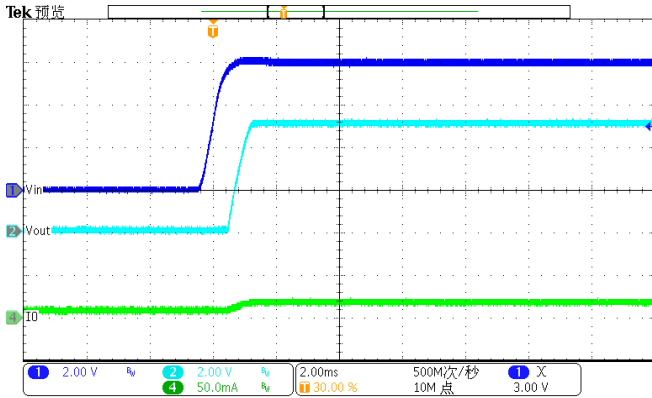

Figure 27. Power up (Iload=10mA)

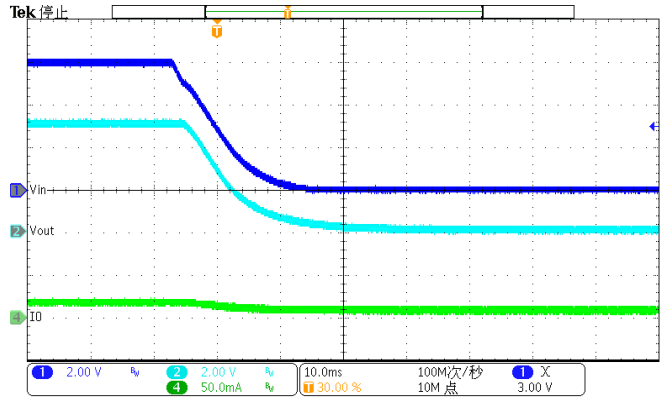

Figure 28. Power down (Iload=10mA)

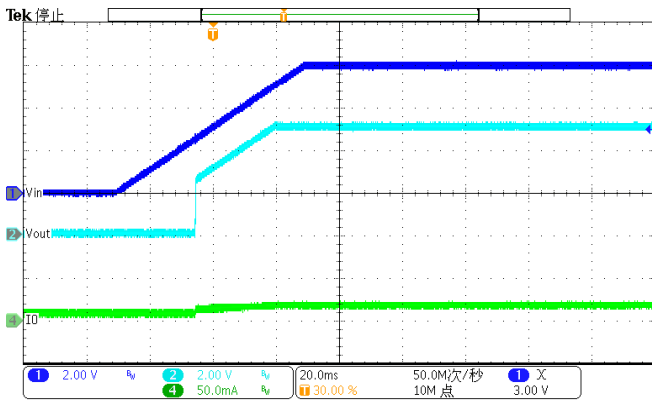

Figure 29. Slow Power up (Iload=10mA)

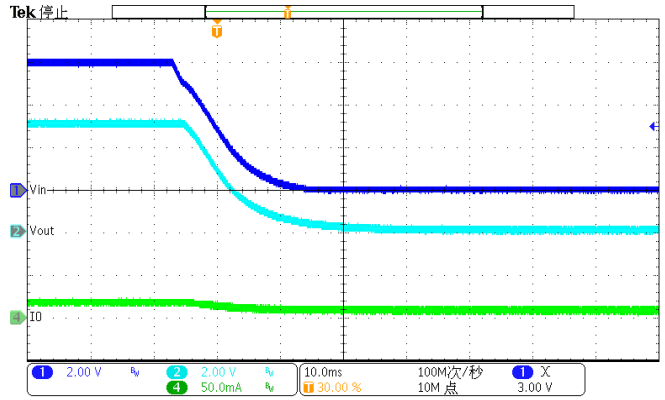

Figure 30. Slow Power down (Iload=10mA)

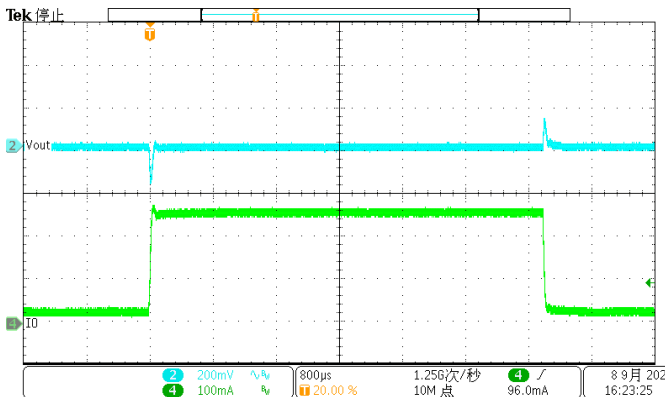

Figure 31. DC-DC Load Transient  
(30mA-270mA),  $V_{OUT} = 5V$

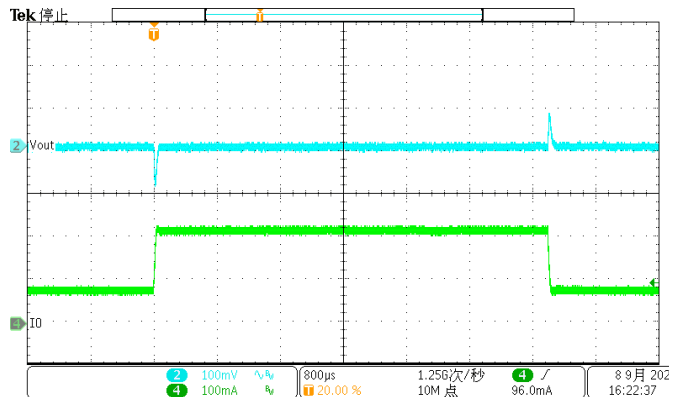

Figure 32. DC-DC Load Transient  
(80mA-220mA),  $V_{OUT} = 5V$

# SCT71403A05Q Series

## Application Waveforms(Continued)

Vin=Vout +1V, unless otherwise noted

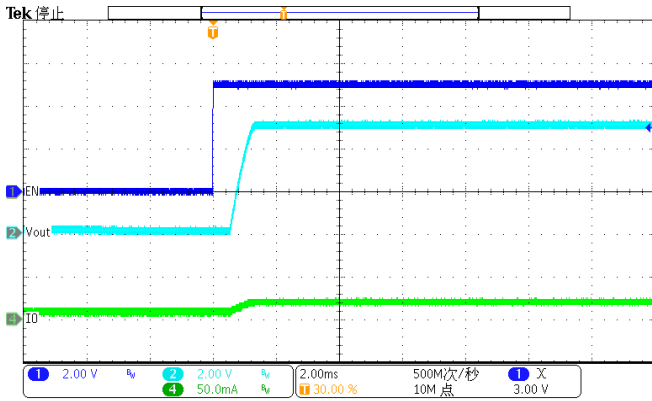

Figure 33. Enable (Iload=10mA)

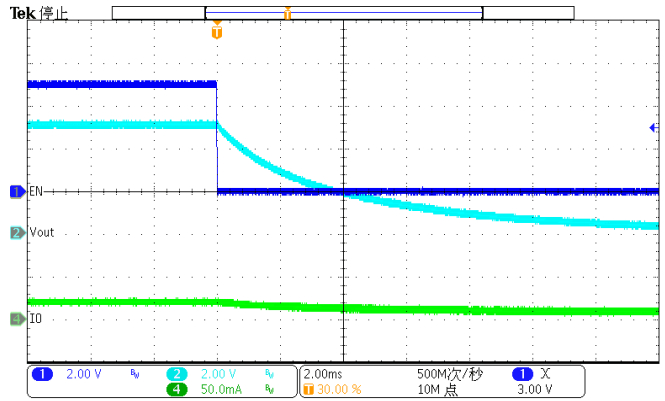

Figure 34. Disable (Iload=10mA)

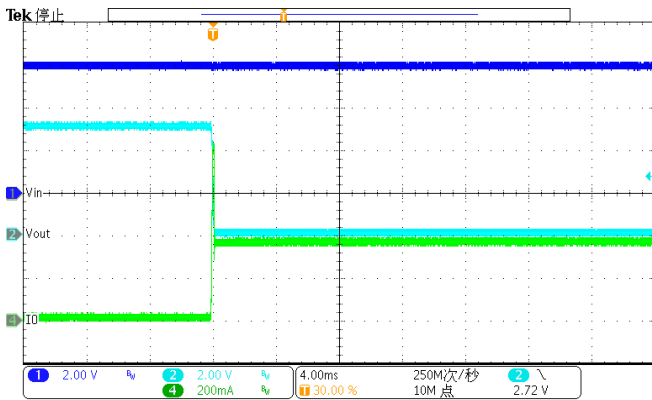

Figure 35. Enter Over Current Protection (Iload=1A)

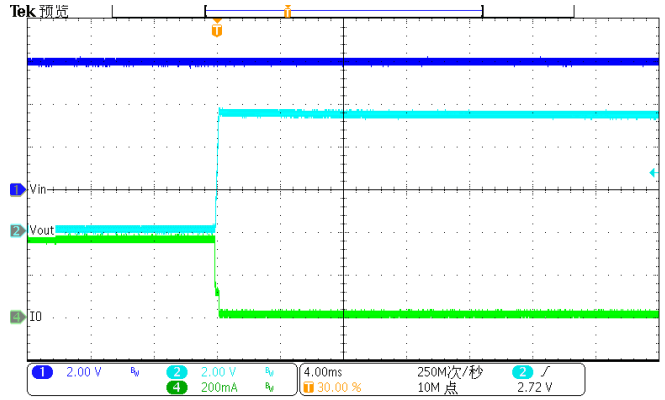

Figure 36. Exit Over Current Protection (Iload=1A)

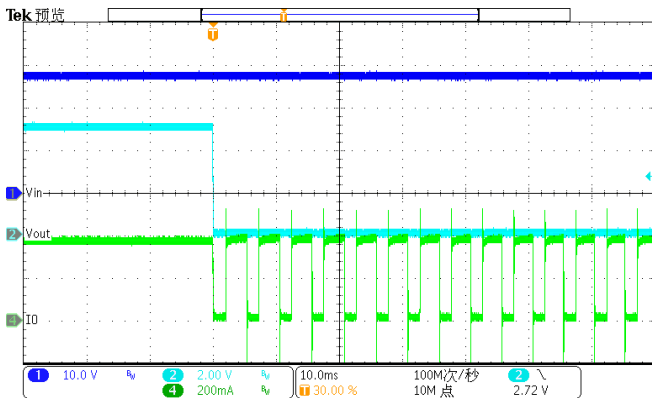

Figure 37. Enter Over Temperature Protection(Vin=24V)

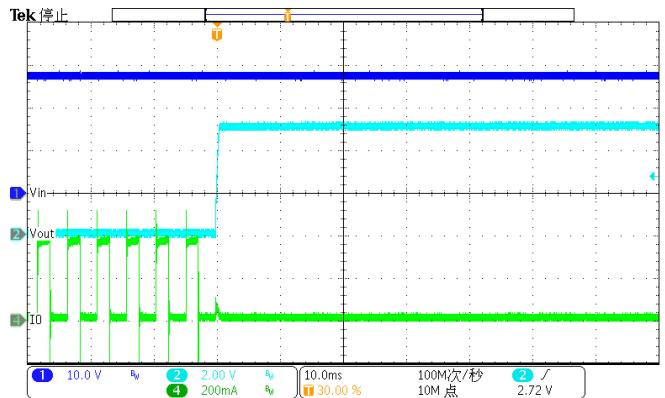

Figure 38. Exit Over Temperature Protection(Vin=24V)

## Layout Guideline

Proper PCB layout is a critical for SCT71403A05Q's stability, transient performance and good regulation characteristics. For better results, follow these guidelines as below:

1. Both input capacitors and output capacitors must be placed as close to the device pins as possible.
2. It is recommended to bypass the input pin to ground with a 0.1 $\mu$ F bypass capacitor. The loop area formed by the bypass capacitor connection,  $V_{IN}$  pin and the GND pin of the system must be as small as possible.
3. It is recommended to use wide trace lengths or thick copper weight to minimize  $I \times R$  drop and heat dissipation.
4. To improve the thermal performance of the device, and maximize the current output at high ambient temperature, SCT recommends spreading the copper under the thermal pad as far as possible and placing enough thermal vias on the copper under the thermal pad.
5. If using large electrolytic capacitor with high ESR resistor, SCT recommends adding a 10 $\mu$ F low ESR capacitor parallel connection with the large electrolytic capacitor.

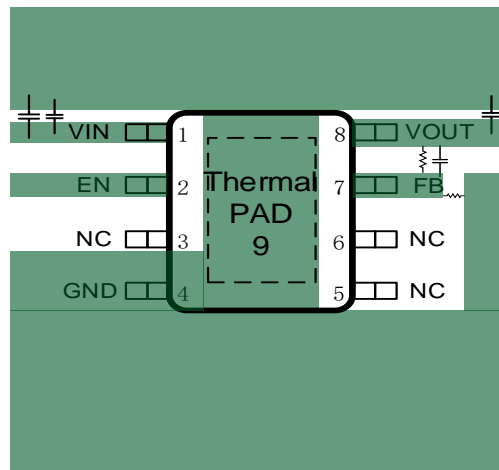
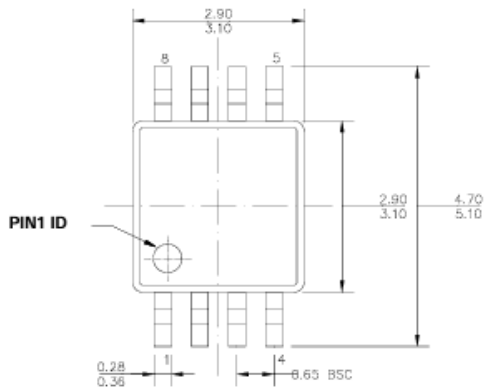

Figure 39. PCB Layout Example

**SCT71403A05QMTER**

# SCT71403A05Q Series

## PACKAGE INFORMATION



**TOP VIEW**

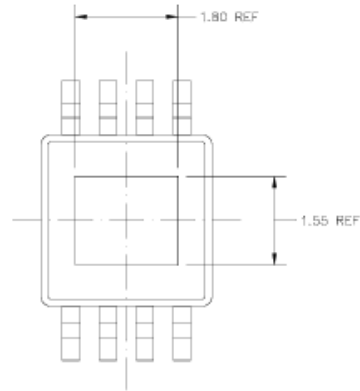

**BOTTOM VIEW**

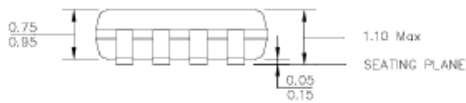

**FRONT VIEW**



**SIDE VIEW**

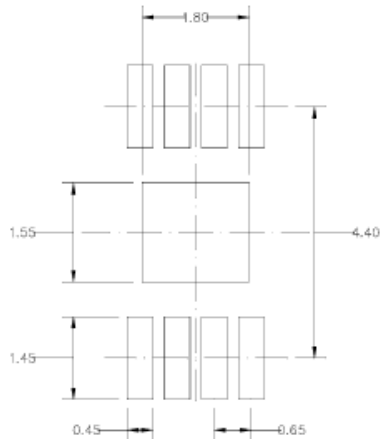

**RECOMMENDED LAND PATTERN**

EMSOP-8L Package Outline Dimensions

**NOTE:**

- 1) ALL DIMENSIONS ARE IN MILLIMETERS.
- 2) PACKAGE LENGTH DOES NOT INCLUDE MOLD FLASH, PROTRUSION OR GATE BURR.
- 3) DRAWING MEETS JEDEC MO-187, VARIATION BA.
- 4) DRAWING IS NOT TO SCALE.

**NOTE:**

- 1. Drawing proposed to be made a JEDEC package outline MO-220 variation.
- 2. Drawing not to scale.
- 3. All linear dimensions are in millimeters.
- 4. Thermal pad shall be soldered on the board.
- 5. Dimensions of exposed pad on bottom of package do not include mold flash.
- 6. Contact PCB board fabrication for minimum solder mask web tolerances between the pins.

## TAPE AND REEL INFORMATION

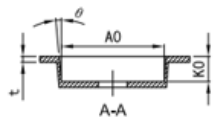
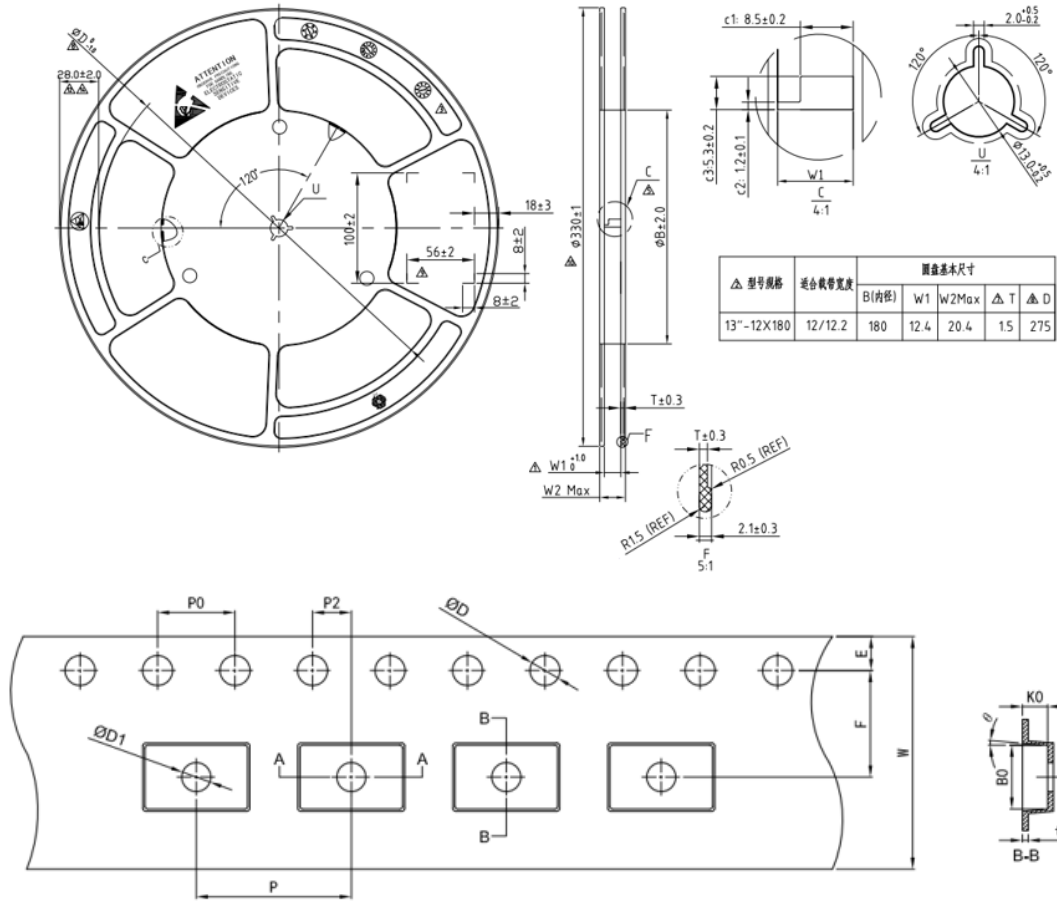

共同尺寸	
外观	尺寸(mm)
E	1.75±0.10
F	5.50±0.10
P2	2.00±0.10
D	1.55±0.05
D1	1.55±0.05
P0	4.00±0.10
10P0	40.00±0.20

口袋尺寸	
外观	尺寸(mm)
W	12.00±0.30
P	8.00±0.10
A0	5.40±0.10
B0	3.40±0.10
K0	1.40±0.10
t	0.30±0.05
θ	3-5° TYP

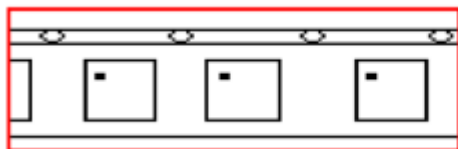

➔ User Direction of Feed

EMSOP-8L

**NOTICE:** The information in this document is subject to change without notice. Users should warrant and guarantee the third party Intellectual Property rights are not infringed upon when integrating Silicon Content Technology (SCT) products into any application. SCT will not assume any legal responsibility for any said applications.