

3.8V-40V Vin, 3A, High Efficiency Synchronous Step-down DCDC Converter with Programmable Frequency

FEATURES

- Wide Input Range: 3.8V-40V
- Up to 3A Continuous Output Current
- 0.8V \pm 1% Feedback Reference Voltage
- Integrated 160m Ω High-Side and 90m Ω Low-Side Power MOSFETs
- Pulse Skipping Mode (PSM) with 25uA Quiescent Current in Sleep Mode
- 100ns Minimum On-time
- 2ms Internal Soft-start Time
- Adjustable Frequency 100kHz to 2.2MHz
- External Clock Synchronization
- Frequency Spread Spectrum (FSS) Modulation for EMI Reduction
- Precision Enable Threshold for Programmable Input Voltage Under-Voltage Lock Out Protection (UVLO) Threshold and Hysteresis
- Low Dropout Mode Operation
- Derivable Inverting Voltage Regulator
- Over-voltage and Over-Temperature Protection
- Available in an ESOP-8 Package

APPLICATIONS

- Battery Pack Powered System - Cordless Power Tools, Cordless Home Appliance, Drone, Aero Modeling, GPS Tracker etc.
- Cigarette Lighter Adapters, Chargers
- LCD Display
- USB Type-C Power Delivery, USB Charging
- Industrial and Medical Distributed Power Supplies
- Optical Communication and Networking System
- Automotive System

DESCRIPTION

The SCT2435 is 3A synchronous buck converters with wide input voltage, ranging from 3.8V to 40V, which integrates an 160m Ω high-side MOSFET and an 90m Ω low-side MOSFET. The SCT2435, adopting the peak current mode control, supports the Pulse Skipping Modulation (PSM) with typical 25uA low quiescent current which assists the converter on achieving high efficiency at light load or standby condition.

The SCT2435 features programmable switching frequency from 100 kHz to 2.2MHz with an external resistor, which provides the flexibility to optimize either efficiency or external component size. The converter supports external clock synchronization with a frequency band from 100kHz to 2.2MHz. The SCT2435 allows power conversion from high input voltage to low output voltage with a minimum 100ns on-time of high-side MOSFET.

The device offers fixed 2ms soft start to prevent inrush current during the startup of output voltage ramping. The SCT2435 features external loop compensation to provide the flexibility to optimize either loop stability or loop response.

The SCT2435 offers cycle-by-cycle current limit and hiccup over current protection, thermal shutdown protection, output over-voltage protection and input voltage under-voltage protection. The device is available in an 8-pin thermally enhanced SOP-8 package.

TYPICAL APPLICATION

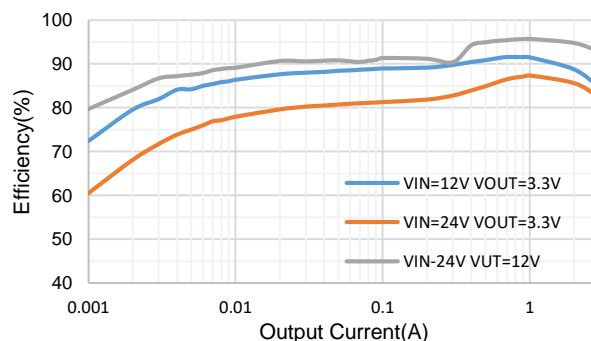
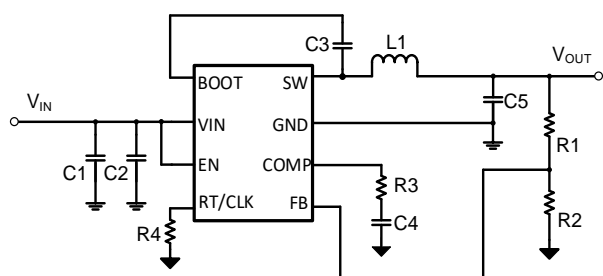

REVISION HISTORY

NOTE: Page numbers for previous revisions may differ from page numbers in the current version.

Revision 1.0: Production

DEVICE ORDER INFORMATION

PART NUMBER	PACKAGE MARKING	PACKAGE DISCRIPTION
SCT2435STE	2435	8-Lead Plastic ESOP
1) For Tape & Reel, Add Suffix R (e.g. SCT2435STER)		

ABSOLUTE MAXIMUM RATINGS

Over operating free-air temperature unless otherwise noted⁽¹⁾

DESCRIPTION	MIN	MAX	UNIT
VIN, EN	-0.3	42	V
BOOT	-0.3	46	V
SW	-0.3	42	V
BOOT-SW	-0.3	6	V
COMP, FB, RT/CLK	-0.3	6	V
Operating junction temperature T _J ⁽²⁾	-40	150	°C
Storage temperature T _{STG}	-65	150	°C

PIN CONFIGURATION

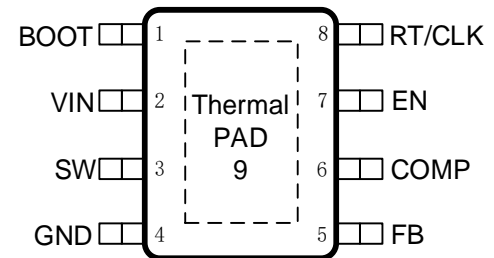

Figure 1. 8-Lead Plastic E-SOP

- (1) Stresses beyond those listed under Absolute Maximum Rating may cause device permanent damage. The device is not guaranteed to function outside of its Recommended Operation Conditions.
- (2) The IC includes over temperature protection to protect the device during overload conditions. Junction temperature will exceed 150°C when over temperature protection is active. Continuous operation above the specified maximum operating junction temperature will reduce lifetime.

PIN FUNCTIONS

NAME	NO.	PIN FUNCTION
BOOT	1	Power supply bias for high-side power MOSFET gate driver. Connect a 0.1uF capacitor from BOOT pin to SW pin. Bootstrap capacitor is charged when low-side power MOSFET is on or SW voltage is low.
VIN	2	Input supply voltage. Connect a local bypass capacitor from VIN pin to GND pin. Path from VIN pin to high frequency bypass capacitor and GND must be as short as possible.
SW	3	Regulator switching output. Connect SW to an external power inductor
GND	4	Ground
FB	5	Inverting input of the trans-conductance error amplifier. The tap of external feedback resistor divider from the output to GND sets the output voltage. The device regulates FB voltage to the internal reference value of 0.8V typical.
COMP	6	Error amplifier output. Connect to frequency loop compensation network.

EN	7	Enable pin to the regulator with internal pull-up current source. Pull below 1.1V to disable the converter. Float or connect to VIN to enable the converter. The tap of resistor divider from VIN to GND connecting EN pin can adjust the input voltage lockout threshold.
RT/CLK	8	Set the internal oscillator clock frequency or synchronize to an external clock. Connect a resistor from this pin to ground to set switching frequency. An external clock can be input directly to the RT/CLK pin. The internal oscillator synchronizes to the external clock frequency with PLL. If detected clocking edges stops, the operation mode automatically returns to resistor programmed frequency.
Thermal Pad	9	Heat dissipation path of die. Electrically connection to GND pin. Must be connected to ground plane on PCB for proper operation and optimized thermal performance.

RECOMMENDED OPERATING CONDITIONS

Over operating free-air temperature range unless otherwise noted

PARAMETER	DEFINITION	MIN	MAX	UNIT
V _{IN}	Input voltage range	3.8	40	V
V _{OUT}	Output voltage range	0.8	40	V
T _J	Operating junction temperature	-40	125	°C

ESD RATINGS

PARAMETER	DEFINITION	MIN	MAX	UNIT
V _{ESD}	Human Body Model(HBM), per ANSI-JEDEC-JS-001-2014 specification, all pins ⁽¹⁾	-2	+2	kV
	Charged Device Model(CDM), per ANSI-JEDEC-JS-002-2014 specification, all pins ⁽²⁾	-0.5	+0.5	kV

(1) JEDEC document JEP155 states that 500V HBM allows safe manufacturing with a standard ESD control process.

(2) JEDEC document JEP157 states that 250V CDM allows safe manufacturing with a standard ESD control process.

THERMAL INFORMATION

PARAMETER	THERMAL METRIC	ESOP-8L	UNIT
R _{θJA}	Junction to ambient thermal resistance ⁽¹⁾	42	°C/W
R _{θJC}	Junction to case thermal resistance ⁽¹⁾	45.8	

(1) SCT provides R_{θJA} and R_{θJC} numbers only as reference to estimate junction temperatures of the devices. R_{θJA} and R_{θJC} are not a characteristic of package itself, but of many other system level characteristics such as the design and layout of the printed circuit board (PCB) on which the SCT2435 is mounted, thermal pad size, and external environmental factors. The PCB board is a heat sink that is soldered to the leads and thermal pad of the SCT2435. Changing the design or configuration of the PCB board changes the efficiency of the heat sink and therefore the actual R_{θJA} and R_{θJC}.

ELECTRICAL CHARACTERISTICS

V_{IN}=24V, T_J=-40°C~125°C, typical value is tested under 25°C.

SYMBOL	PARAMETER	TEST CONDITION	MIN	TYP	MAX	UNIT
Power Supply						
V _{IN}	Operating input voltage		3.8		40	V
V _{IN_UVLO}	Input UVLO Threshold	V _{IN} rising		3.5	3.7	V
	Hysteresis			400		mV
I _{SHDN}	Shutdown current from VIN pin	EN=0, no load		1	3	μA

SCT2435

I_Q	Quiescent current from VIN pin	EN floating, no load, non-switching, BOOT-SW=5V	25	μA
-------	--------------------------------	---	----	---------

Power MOSFETs

$R_{DS(on)_H}$	High-side MOSFET on-resistance	$V_{BOOT}-V_{SW}=5V$	160	$m\Omega$
$R_{DS(on)_L}$	Low-side MOSFET on-resistance		90	$m\Omega$

Reference and Control Loop

V_{REF}	Reference voltage of FB		0.792	0.8	0.808	V
G_{EA}	Error amplifier trans-conductance	$-2\mu A < I_{COMP} < 2\mu A, V_{COMP}=1V$	300			μS
I_{COMP_SRC}	EA maximum source current	$V_{FB}=V_{REF}-100mV, V_{COMP}=1V$	30			μA
I_{COMP_SNK}	EA maximum sink current	$V_{FB}=V_{REF}+100mV, V_{COMP}=1V$	30			μA
V_{COMP_H}	COMP high clamp		3			V
V_{COMP_L}	COMP low clamp		0.4			V

Current Limit and Over Current Protection

I_{LIM_HS}	High-side power MOSFET peak current limit threshold		4			A
I_{LIM_LSSRC}	Low-side power MOSFET sourcing current limit threshold		3.2			A
T_{HIC_W}	Over current protection hiccup wait time		512			cycles
T_{HIC_R}	Over current protection hiccup restart time		8192			cycles

Enable and Soft Startup

V_{EN_H}	Enable high threshold		1.18	1.25		V
V_{EN_L}	Enable low threshold		1.03	1.1		V
I_{EN_L}	Enable pin pull-up current	EN=1V	1	1.5	2	μA
I_{EN_H}	Enable pin pull-up current	EN=1.5V	5.5			μA
T_{SS}	Internal soft start time		2			ms

Switching Frequency and External Clock Synchronization

F_{RANGE_RT}	Frequency range using RT mode		100		2200	kHz
F_{SW}	Switching frequency	$R_{RT}=200\text{ k}\Omega(1\%)$	450	500	550	kHz
F_{RANGE_CLK}	Frequency range using CLK mode		100		2200	kHz
F_{JITTER}	Frequency spread spectrum in percentage of Fsw			± 6		%
t_{ON_MIN}	Minimum on-time	$V_{IN}=24V$	100			ns

Protection

V_{OVP}	Feedback overvoltage with respect to reference voltage	V_{FB}/V_{REF} rising V_{FB}/V_{REF} falling	110 105			% %
V_{BOOTUV}	BOOT-SW UVLO threshold	BOOT-SW falling Hysteresis	2.36 300			V mV
T_{SD}	Thermal shutdown threshold*	T_J rising Hysteresis	160 10			$^{\circ}C$ $^{\circ}C$

*Derived from bench characterization

TYPICAL CHARACTERISTICS

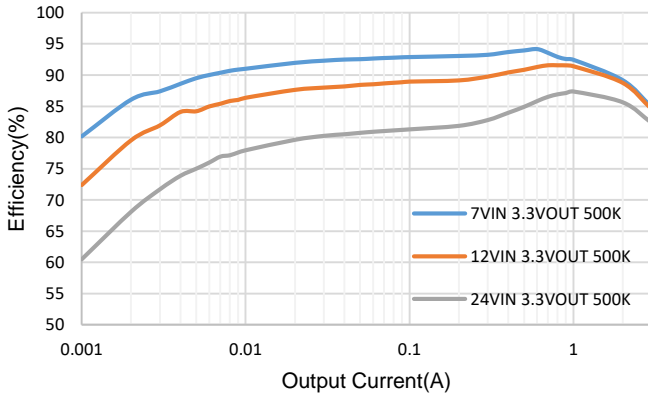

Figure 2. Efficiency vs Load Current, VOUT=3.3V, 500KHz

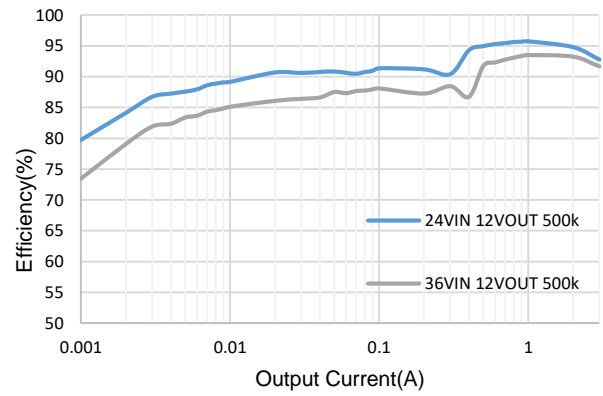

Figure 3. Efficiency vs Load Current, VOUT=12V, 500KHz

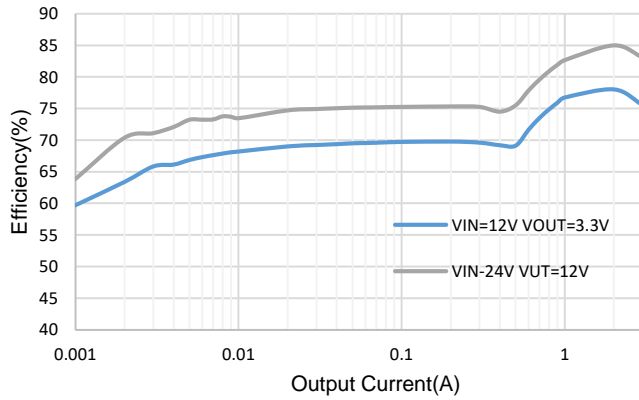

Figure 4. Efficiency vs Load Current, 2MHz

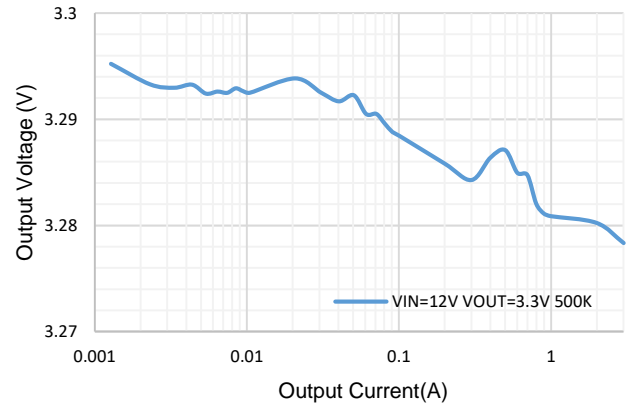

Figure 5. Load Regulation (VIN=12V, VOUT=3.3V)

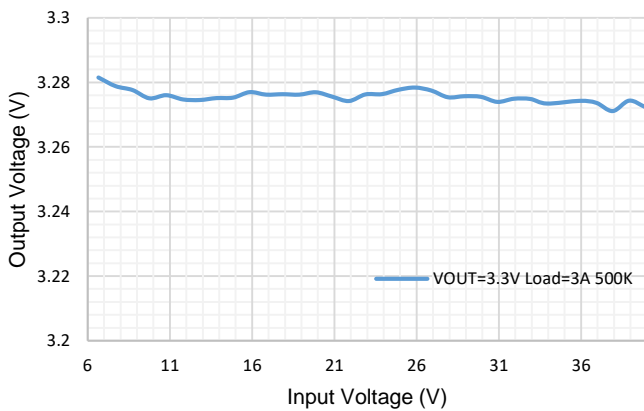

Figure 6. Line Regulation (IOUT=3A)

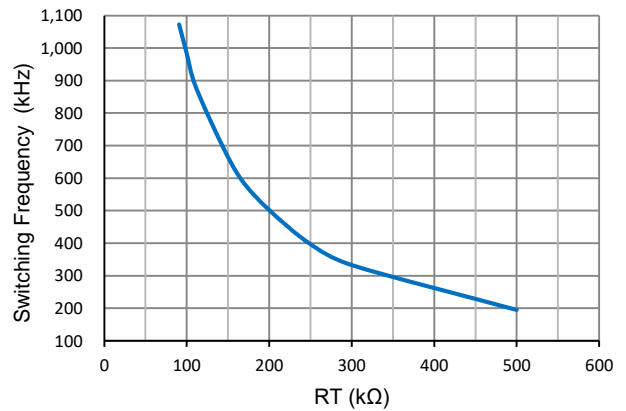

Figure 7. Clock Frequency vs RT/CLK Resistor

FUNCTIONAL BLOCK DIAGRAM

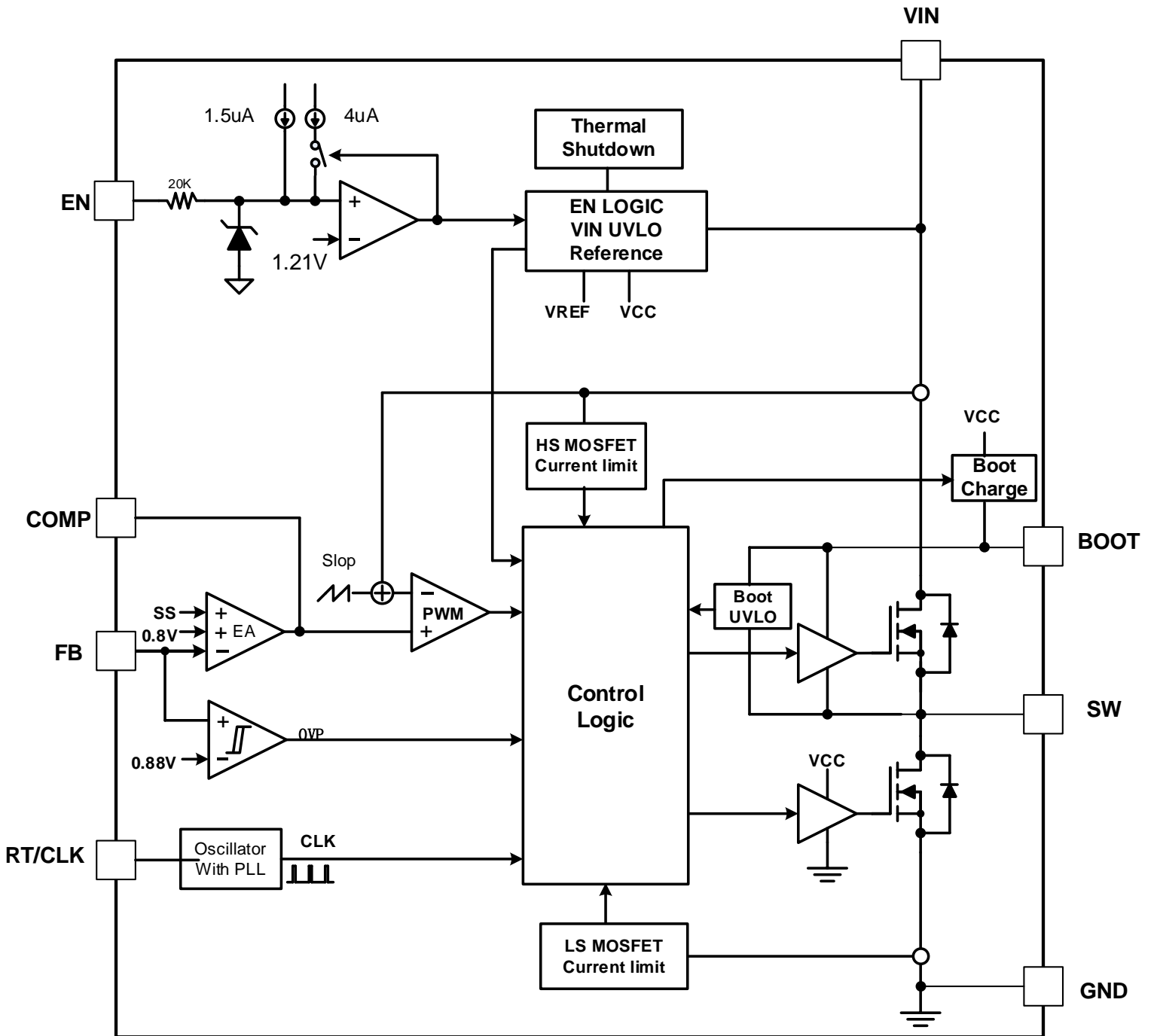

Figure 8. Functional Block Diagram

OPERATION

Overview

The SCT2435 is a 3.8V-40V input, 3A output, EMI friendly synchronous buck converter with built-in 160mΩ R_{ds(on)} high-side and 90mΩ R_{ds(on)} low-side power MOSFETs. It implements constant frequency peak current mode control to regulate output voltage, providing excellent line and load transient response and simplifying the external frequency compensation design.

The switching frequency is programmable from 100kHz to 2.2MHz with two setting modes, resistor setting frequency mode and the clock synchronization mode, to optimize either the power efficiency or the external components' sizes. The SCT2435 features an internal 2ms soft-start time to avoid large inrush current and output voltage overshoot during startup. The device also supports monolithic startup with pre-biased output condition. The seamless mode-transition between PWM mode and PSM mode operations ensure high efficiency over wide load current range. The quiescent current is typically 25μA under no load or sleep mode condition to achieve high efficiency at light load.

The SCT2435 has a default input start-up voltage of 3.5V with 400mV hysteresis. The EN pin is a high-voltage pin with a precision threshold that can be used to adjust the input voltage lockout thresholds with two external resistors to meet accurate higher UVLO system requirements. Floating EN pin enables the device with the internal pull-up current to the pin. Connecting EN pin to VIN directly starts up the device automatically.

The SCT2435 full protection features include the input under-voltage lockout, the output over-voltage protection, over current protection with cycle-by-cycle current limiting and hiccup mode, output hard short protection and thermal shutdown protection.

Peak Current Mode Control

The SCT2435 employs fixed frequency peak current mode control. An internal clock initiates turning on the integrated high-side power MOSFET Q1 in each cycle, then inductor current rises linearly. When the current through high-side MOSFET reaches the threshold level set by the COMP voltage of the internal error amplifier, the high-side MOSFET turns off. The synchronous low-side MOSFET Q2 turns on till the next clock cycle begins or the inductor current falls to zero.

The error amplifier serves the COMP node by comparing the voltage of the FB pin with an internal 0.8V reference voltage. When the load current increases, a reduction in the feedback voltage relative to the reference raises COMP voltage till the average inductor current matches the increased load current. This feedback loop well regulates the output voltage to the reference. The device also integrates an internal slope compensation circuitry to prevent sub-harmonic oscillation when duty cycle is greater than 50% for a fixed frequency peak current mode control.

The SCT2435 operates in Pulse Skipping Mode (PSM) with light load current to improve efficiency. When the load current decreases, an increment in the feedback voltage leads COMP voltage drop. When COMP falls to a low clamp threshold (400mV typically), device enters PSM. The output voltage decays due to output capacitor discharging during skipping period. Once FB voltage drops lower than the reference voltage, and the COMP voltage rises above low clamp threshold. Then high-side power MOSFET turns on in next clock pulse. After several switching cycles with typical 1A peak inductor current, COMP voltage drops and is clamped again and pulse skipping mode repeats if the output continues light loaded.

This control scheme helps achieving higher efficiency by skipping cycles to reduce switching power loss and gate drive charging loss. The controller consumption quiescent current is 25μA during skipping period with no switching to improve efficiency further.

Enable and Under Voltage Lockout Threshold

The SCT2435 is enabled when the VIN pin voltage rises about 3.5V and the EN pin voltage exceeds the enable threshold of 1.18V. The device is disabled when the VIN pin voltage falls below 3.1V or when the EN pin voltage is below 1.1V. An internal 1.5μA pull up current source to EN pin allows the device enable when EN pin floats.

EN pin is a high voltage pin that can be connected to VIN directly to start up the device.

SCT2435

For a higher system UVLO threshold, connect an external resistor divider (R1 and R2) shown in Figure 9 from VIN to EN. The UVLO rising and falling threshold can be calculated by Equation 1 and Equation 2 respectively.

$$V_{\text{rise}} = 1.18 * \left(1 + \frac{R1}{R2}\right) - 1.5\mu\text{A} * R1 \quad (1)$$

$$V_{\text{fall}} = 1.1 * \left(1 + \frac{R1}{R2}\right) - 5.5\mu\text{A} * R1 \quad (2)$$

where

- V_{rise} is rising threshold of Vin UVLO
- V_{fall} is falling threshold of Vin UVLO

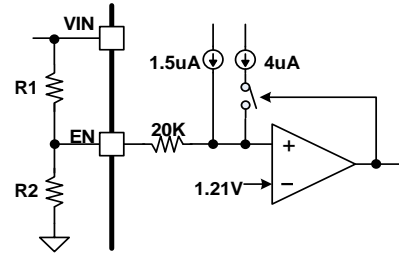

Figure 9. System UVLO by enable divide

Output Voltage

The SCT2435 regulates the internal reference voltage at 0.8V with $\pm 1\%$ tolerance over the operating temperature and voltage range. The output voltage is set by a resistor divider from the output node to the FB pin. It is recommended to use 1% tolerance or better resistors. Use Equation 3 to calculate resistance of resistor dividers. To improve efficiency at light loads, larger value resistors are recommended. However, if the values are too high, the regulator will be more susceptible to noise affecting output voltage accuracy.

$$R_{FB_TOP} = \left(\frac{V_{OUT}}{V_{REF}} - 1\right) * R_{FB_BOT} \quad (3)$$

where

- R_{FB_TOP} is the resistor connecting the output to the FB pin.
- R_{FB_BOT} is the resistor connecting the FB pin to the ground.

Internal Soft-Start

The SCT2435 integrates an internal soft-start circuit that ramps the reference voltage from zero volts to 0.8V reference voltage in 2ms. If the EN pin is pulled below 1.1V, switching stops and the internal soft-start resets. The soft-start also resets during shutdown due to thermal overloading.

Switching Frequency and Clock Synchronization

The switching frequency of the SCT2435 is set by placing a resistor between RT/CLK pin and the ground, or synchronizing to an external clock.

In resistor setting frequency mode, a resistor placed between RT/CLK pin to the ground sets the switching frequency over a wide range from 100KHz to 2.2MHz. The RT/CLK pin voltage is typical 0.5V. RT/CLK pin is not allowed to be left floating or shorted to the ground. Use Equation 4 or the plot in Figure 10. to determine the resistance for a switching frequency needed.

$$RT(K\Omega) = \frac{100000}{fsw(KHz)} \quad (4)$$

where,

fsw is switching clock frequency

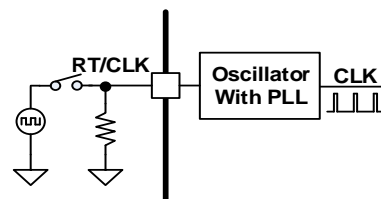

Figure 10. Setting Frequency and Clock Synchronization

In clock synchronization mode, the switching frequency synchronizes to an external clock applied to RT/CLK pin. The synchronization frequency range is from 100KHz to 2.2MHz and the rising edge of the SW synchronizes to the

falling edge of the external clock at RT/CLK pin with typical 66ns time delay. A square wave clock signal to RT/CLK pin must have high level no lower than 2V, low level no higher than 0.4V, and pulse width larger than 80ns.

In applications where both resistor setting frequency mode and clock synchronization mode are needed, the device can be configured as shown in Figure 16. Before an external clock is present, the device works in resistor setting frequency mode. When an external clock presents, the device automatically transitions from resistor setting mode to external clock synchronization mode. An internal phase locked loop PLL locks internal clock frequency onto the external clock within typical 85us. The converter transitions from the clock synchronization mode to the resistor setting frequency mode when the external clock disappears.

Bootstrap Voltage Regulator and Low Drop-out Operation

An external bootstrap capacitor between BOOT pin and SW pin powers the floating gate driver to high-side power MOSFET. The bootstrap capacitor voltage is charged from an integrated voltage regulator when high-side power MOSFET is off and low-side power MOSFET is on.

The UVLO of high-side MOSFET gate driver has rising threshold of 2.7V and hysteresis of 350mV. When the device operates with high duty cycle or extremely light load, bootstrap capacitor may be not recharged in considerable long time. The voltage at bootstrap capacitor is insufficient to drive high-side MOSFET fully on. When the voltage across bootstrap capacitor drops below 2.35V, BOOT UVLO occurs. The converter forces turning on low-side MOSFET periodically to refresh the voltage of bootstrap capacitor to guarantee the operation over a wide duty range.

During the condition of ultra-low voltage difference from the input to the output, SCT2420 operates in Low Drop-Out LDO mode. High-side MOSFET remains turning on as long as the BOOT pin to SW pin voltage is higher than BOOT UVLO threshold 2.7V. When the voltage from BOOT to SW drops below 2.4V, the high-side MOSFET turns off and low-side MOSFET turns on to recharge bootstrap capacitor periodically in the following several switching cycles. Low-side MOSFET turns on for 100ns in each refresh cycle to minimize the output voltage ripple. Low-side MOSFET may turn on for several times till the bootstrap voltage is charged to higher than 2.7V for high-side MOSFET working normally. The effective duty cycle of the converter during LDO operation can be approaching to 100%

During slowing power up and power down application, the output voltage can closely track the input voltage ramping down thanks to LDO operation mode. As the input voltage is reduced to near the output voltage, i.e. during slowing power-up and power-down application, the off-time of the high side MOSFET starts to approach the minimum value. Without LDO operation mode, beyond this point the switching may become erratic and/or the output voltage will fall out of regulation. To avoid this problem, the SCT2435 LDO mode automatically reduces the switching frequency to increase the effective duty cycle and maintain regulation.

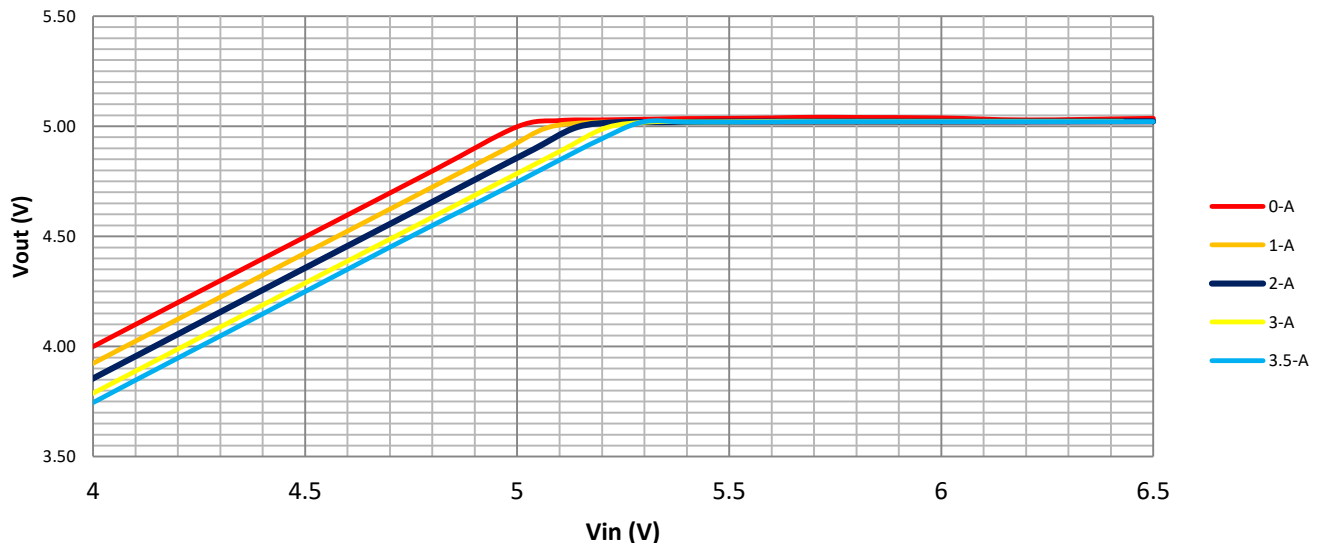

Figure 11. LDO Operation Characteristic (Vout =5V)

Over Current Limit and Hiccup Mode

The inductor current is monitored during high-side MOSFET Q1 and low-side MOSFET Q2 on. The SCT2435 implements over current protection with cycle-by-cycle limiting high-side MOSFET peak current and low-side MOSFET valley current to avoid inductor current running away during unexpected overload or output hard short condition.

When overload or hard short happens, the converter cannot provide output current to satisfy loading requirement. The inductor current is clamped at over current limitation. Thus, the output voltage drops below regulated voltage with FB voltage less than internal reference voltage continuously. The COMP pin voltage ramps up to high clamp voltage 3.7V typical. When COMP voltage is clamped for 512 cycles, the converter stops switching. After remaining OFF for 8192 cycles, the device restarts from soft starting phase. If overload or hard short condition still exists during soft-start and make COMP voltage clamped at high for 512 cycles, the device enters into turning-off mode again. When overload or hard short condition is removed, the device automatically recovers to enter normal regulating operation.

The hiccup protection mode above makes the average short circuit current to alleviate thermal issues and protect the regulator.

Over voltage Protection

The SCT2435 implements the Over-voltage Protection OVP circuitry to minimize output voltage overshoot during load transient, recovering from output fault condition or light load transient. The overvoltage comparator in OVP circuit compares the FB pin voltage to the internal reference voltage. When FB voltage exceeds 110% of internal 0.8V reference voltage, the high-side MOSFET turns off to avoid output voltage continue to increase. When the FB pin voltage falls below 105% of the 0.8V reference voltage, the high-side MOSFET can turn on again.

Thermal Shutdown

The SCT2435 protects the device from the damage during excessive heat and power dissipation conditions. Once the junction temperature exceeds 160°C, the internal thermal sensor stops power MOSFETs switching. When the junction temperature falls below 150°C, the device restarts with internal soft start phase.

APPLICATION INFORMATION

Typical Application

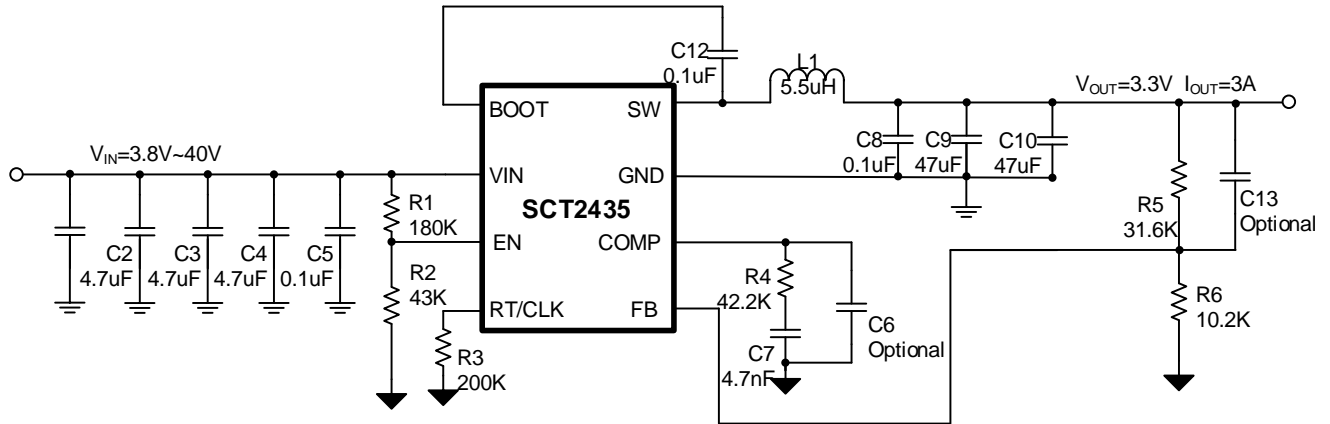

Figure 12. SCT2435 Design Example, 3.3V Output with Programmable UVLO

Design Parameters

Design Parameters	Example Value
Input Voltage	24V Normal 3.8V to 40V
Output Voltage	3.3V
Maximum Output Current	3A
Switching Frequency	500 KHz
Output voltage ripple (peak to peak)	16.5mV
Start Input Voltage (rising VIN)	5.76V
Stop Input Voltage (falling VIN)	4.66V

Output Voltage

The output voltage is set by an external resistor divider R5 and R6 in typical application schematic. Recommended R6 resistance is 10.2KΩ. Use equation 5 to calculate R5.

$$R_5 = \left(\frac{V_{OUT}}{V_{REF}} - 1 \right) * R_6 \quad (5)$$

where:

- V_{REF} is the feedback reference voltage, typical 0.8V

Table 1. R₅, R₆ Value for Common Output Voltage (Room Temperature)

V _{OUT}	R ₅	R ₆
1.8 V	12.7 KΩ	10.2 KΩ
2.5 V	21.5 KΩ	10.2 KΩ
3.3 V	31.6 KΩ	10.2 KΩ
5 V	53.6 KΩ	10.2 KΩ
12 V	143 KΩ	10.2 KΩ
24V	294 KΩ	10.2 KΩ

Switching Frequency

Higher switching frequencies support smaller profiles of output inductors and output capacitors, resulting in lower voltage and current ripples. However, the higher switching frequency causes extra switching loss, which downgrades converter's overall power efficiency and thermal performance. The 100ns minimum on-time limitation also restricts the selection of higher switching frequency. In this design, a moderate switching frequency of 500 kHz is selected to achieve both small solution size and high efficiency operation.

The resistor connected from RT/CLK to GND sets switching frequency of the converter. The resistor value required for a desired frequency can be calculated using equation 6, or determined from Figure 7.

$$RT(K\Omega) = \frac{100000}{f_{sw} (KHz)} \quad (6)$$

where:

- f_{sw} is the desired switching frequency

Table 2. R_{FSW} Value for Common Switching Frequencies (Room Temperature)

F _{sw}	R ₃ (R _{FSW})
200 KHz	500 KΩ
330 KHz	301 KΩ
500 KHz	200 KΩ
1100 KHz	90.9 KΩ

Under Voltage Lock-Out

An external voltage divider network of R₁ from the input to EN pin and R₂ from EN pin to the ground can set the input voltage's Under Voltage Lock-Out (UVLO) threshold, like shown in Figure 15. The UVLO has two thresholds, one for power up when the input voltage is rising and the other for power down or brown outs when the input voltage is falling. For the example design, the supply should turn on and start switching once the input voltage increases above 5.76V (start or enable). After the regulator starts switching, it should continue to do so until the input voltage falls below 4.66 V (stop or disable). Use Equation 7 and Equation 8 to calculate the values 180 kΩ and 43 kΩ of R₁ and R₂ resistors.

$$V_{rise} = 1.18 * \left(1 + \frac{R_1}{R_2} \right) - 1.5\mu A * R_1 \quad (7)$$

$$V_{fall} = 1.1 * \left(1 + \frac{R_1}{R_2} \right) - 5.5\mu A * R_1 \quad (8)$$

Inductor Selection

There are several factors should be considered in selecting inductor such as inductance, saturation current, the RMS current and DC resistance(DCR). Larger inductance results in less inductor current ripple and therefore leads

to lower output voltage ripple. However, the larger value inductor always corresponds to a bigger physical size, higher series resistance, and lower saturation current. A good rule for determining the inductance to use is to allow the inductor peak-to-peak ripple current to be approximately 20%~40% of the maximum output current.

The peak-to-peak ripple current in the inductor I_{LPP} can be calculated as in Equation 9.

$$I_{LPP} = \frac{V_{OUT} * (V_{IN} - V_{OUT})}{V_{IN} * L * f_{SW}} \quad (9)$$

Where

- I_{LPP} is the inductor peak-to-peak current
- L is the inductance of inductor
- f_{SW} is the switching frequency
- V_{OUT} is the output voltage
- V_{IN} is the input voltage

Since the inductor-current ripple increases with the input voltage, so the maximum input voltage in application is always used to calculate the minimum inductance required. Use Equation 10 to calculate the inductance value.

$$L_{MIN} = \frac{V_{OUT}}{f_{SW} * LIR * I_{OUT(max)}} * \left(1 - \frac{V_{OUT}}{V_{IN(max)}}\right) \quad (10)$$

Where

- L_{MIN} is the minimum inductance required
- f_{sw} is the switching frequency
- V_{OUT} is the output voltage
- $V_{IN(max)}$ is the maximum input voltage
- $I_{OUT(max)}$ is the maximum DC load current
- LIR is coefficient of I_{LPP} to I_{OUT}

The total current flowing through the inductor is the inductor ripple current plus the output current. When selecting an inductor, choose its rated current especially the saturation current larger than its peak operation current and RMS current also not be exceeded. Therefore, the peak switching current of inductor, I_{LPEAK} and I_{LRMS} can be calculated as in equation 11 and equation 12.

$$I_{LPEAK} = I_{OUT} + \frac{I_{LPP}}{2} \quad (11)$$

$$I_{LRMS} = \sqrt{(I_{OUT})^2 + \frac{1}{12} * (I_{LPP})^2} \quad (12)$$

Where

- I_{LPEAK} is the inductor peak current
- I_{OUT} is the DC load current
- I_{LPP} is the inductor peak-to-peak current
- I_{LRMS} is the inductor RMS current

In overloading or load transient conditions, the inductor peak current can increase up to the switch current limit of the device which is typically 3A. The most conservative approach is to choose an inductor with a saturation current rating greater than 3A. Because of the maximum I_{LPEAK} limited by device, the maximum output current that the SCT2435 can deliver also depends on the inductor current ripple. Thus, the maximum desired output current also affects the selection of inductance. The smaller inductor results in larger inductor current ripple leading to a higher maximum output current.

For this design, use LIR=0.3 or 0.4, and the inductor value is calculated to be 5.5uH, the RMS inductor current is 3A and the peak inductor current is 3.6A. The chosen inductor is a WE 744325550, which has a saturation current rating of 4.5A and a RMS current rating of 10A. This also has a typical inductance of 5.5μH at no load and 5μH at 4A load. The inductor DCR is 10.3 mΩ.

Input Capacitor Selection

The input current to the step-down DCDC converter is discontinuous, therefore it requires a capacitor to supply the AC current to the step-down DCDC converter while maintaining the DC input voltage. Use capacitors with low ESR for better performance. Ceramic capacitors with X5R or X7R dielectrics are usually suggested because of their low ESR and small temperature coefficients, and it is strongly recommended to use another lower value capacitor (e.g. 0.1uF) with small package size (0603) to filter high frequency switching noise. Place the small size capacitor as close to VIN and GND pins as possible.

The voltage rating of the input capacitor must be greater than the maximum input voltage. And the capacitor must also have a ripple current rating greater than the maximum input current ripple. The RMS current in the input capacitor can be calculated using Equation 13.

$$I_{CINRMS} = I_{OUT} * \sqrt{\frac{V_{OUT}}{V_{IN}} * (1 - \frac{V_{OUT}}{V_{IN}})} \quad (13)$$

The worst case condition occurs at $V_{IN}=2*V_{OUT}$, where:

$$I_{CINRMS} = 0.5 * I_{OUT} \quad (14)$$

For simplification, choose an input capacitor with an RMS current rating greater than half of the maximum load current.

When selecting ceramic capacitors, it needs to consider the effective value of a capacitor decreasing as the DC bias voltage across a capacitor increases.

The input capacitance value determines the input ripple voltage of the regulator. The input voltage ripple can be calculated using Equation 15 and the maximum input voltage ripple occurs at 50% duty cycle.

$$\Delta V_{IN} = \frac{I_{OUT}}{f_{SW} * C_{IN}} * \frac{V_{OUT}}{V_{IN}} * (1 - \frac{V_{OUT}}{V_{IN}}) \quad (15)$$

For this example, three 4.7μF, X7R ceramic capacitors rated for 50 V in parallel are used. And a 0.1 μF for high-frequency filtering capacitor is placed as close as possible to the device pins.

Bootstrap Capacitor Selection

A 0.1μF ceramic capacitor must be connected between BOOT pin and SW pin for proper operation. A ceramic capacitor with X5R or better grade dielectric is recommended. The capacitor should have a 10V or higher voltage rating.

Output Capacitor Selection

The selection of output capacitor will affect output voltage ripple in steady state and load transient performance.

The output ripple is essentially composed of two parts. One is caused by the inductor current ripple going through the Equivalent Series Resistance ESR of the output capacitors and the other is caused by the inductor current ripple charging and discharging the output capacitors. To achieve small output voltage ripple, choose a low-ESR output capacitor like ceramic capacitor. For ceramic capacitors, the capacitance dominates the output ripple. For simplification, the output voltage ripple can be estimated by Equation 16 desired.

$$\Delta V_{OUT} = \frac{V_{OUT} * (V_{IN} - V_{OUT})}{8 * f_{SW}^2 * L * C_{OUT} * V_{IN}} \quad (16)$$

Where

- ΔV_{OUT} is the output voltage ripple
- f_{sw} is the switching frequency
- L is the inductance of inductor
- C_{OUT} is the output capacitance
- V_{OUT} is the output voltage
- V_{IN} is the input voltage

Due to capacitor's degrading under DC bias, the bias voltage can significantly reduce capacitance. Ceramic capacitors can lose most of their capacitance at rated voltage. Therefore, leave margin on the voltage rating to ensure adequate effective capacitance. Typically, two 47 μ F ceramic output capacitors work for most applications.

Compensation Components

The SCT2420 employs peak current mode control for easy compensation and fast transient response. An external network comprising resistor R4, ceramic capacitors C7 and optional C6 connected to the COMP pin is used for the loop compensation. The equation 17 shows the close-loop small signal transfer function.

$$H(S) = \left[A_{EA} * \frac{1 + \frac{S}{2\pi * fz1}}{\left(1 + \frac{S}{2\pi * fp1}\right) * \left(1 + \frac{S}{2\pi * fp3}\right)} \right] * \left[G_{ISNS} * \frac{V_{OUT}}{I_{OUT}} * \frac{1 + \frac{S}{2\pi * fz2}}{1 + \frac{S}{2\pi * fp2}} \right] * \frac{V_{FB}}{V_{OUT}} \quad (17)$$

where

- A_{EA} is error amplifier voltage gain
- G_{ISNS} is COMP to SW current trans-conductance, 11.2A/V typically

The DC voltage gain of the loop is given by equation 18.

$$A_{VDC} = A_{EA} * G_{ISNS} * \frac{V_{FB}}{I_{OUT}} \quad (18)$$

The system has two noteworthy poles: one is due to the compensation capacitor C7 and the error amplifier output resistor. The other is caused by the output capacitor and the load resistor. These poles as located at:

$$f_{P1} = \frac{1}{2\pi * R_{OEA} * C_7} = \frac{G_{EA}}{2\pi * A_{EA} * C_7} \quad (19)$$

$$f_{P2} = \frac{1}{2\pi * R_{LOAD} * C_{OUT}} = \frac{I_{OUT}}{2\pi * V_{OUT} * C_{OUT}} \quad (20)$$

Where

- R_{OEA} is error amplifier output resistor
- G_{EA} is Error amplifier trans-conductance, 300uS typically
- R_{LOAD} is equivalent load resistor

The system has one zero of importance from R4 and C7. fz1 is used to counteract the fp2, and fz1 located at:

$$f_{Z1} = \frac{1}{2\pi * C_7 * R_4} \quad (21)$$

The system may have another important zero if the output capacitor has a large capacitance or a high ESR value. The zero, due to the ESR and the capacitance of the output capacitor is calculated by Equation 22.

$$f_{Z2} = \frac{1}{2\pi * C_{OUT} * ESR} \quad (22)$$

In this case, a third pole set by the optional compensation capacitor C6 and the compensation resistor R4 is used to compensate the effect of the ESR zero. This pole is calculated by Equation 23.

$$f_{P3} = \frac{1}{2\pi * C_6 * R_4} \quad (23)$$

The crossover frequency of converter is shown in Equation 24.

$$f_c = \frac{V_{FB}}{V_{OUT}} * \frac{G_{EA} * G_{ISNS} * R_4}{2\pi * C_{OUT}} \quad (24)$$

The system crossover frequency, where the feedback loop has unity gain, is important. A lower crossover frequency results in slower line and load transient response. A higher crossover frequency could cause the system unstable. A recommended rule of thumb is to set the crossover frequency to be approximately 1/10 of switching frequency.

The following steps can be followed to calculate the external compensation components. Calculate the compensation resistor R4 with Equation 25 once crossover frequency is selected.

$$R_4 = \frac{V_{OUT}}{V_{FB}} * \frac{2\pi * C_{OUT} * f_c}{G_{EA} * G_{ISNS}} \quad (25)$$

Then calculate C7 by placing a compensation zero at or before the output stage pole.

$$C_7 = \frac{R_{LOAD} * C_{OUT}}{R_4} \quad (26)$$

Determine if the optional compensation capacitor C6 is required. Generally, it is required if the ESR zero f_{z2} is located less than half of the switching frequency. Then f_{p3} can be used to cancel f_{z2} . C6 can be calculated with Equation 27.

$$C_6 = \frac{C_{OUT} * ESR}{R_4} \quad (27)$$

Table 3 lists typical values of compensation components for some standard output voltages with various output ceramic capacitors and inductors. The values of the compensation components have been optimized for fast transient responses and good stability.

Table 2: Compensation Values for Typical Output Voltage/Capacitor Combinations at fsw=500KHz

Vout	L1	COUT	R4	C7	C6 (optional)
1.8V	3.3uH	2*47uF	20K	6.8nF	100pF
2.5V	4.7uH	2*47uF	30.1K	4.7nF	68pF
3.3V	5.5uH	2*47uF	42.2K	4.7 nF	47pF
5V	6.8uH	2*47uF	56.2K	3.3nF	22pF
12V	10uH	2*47uF	90.9K	1nF	15pF*

Inverting Power application

The SCT2435 can be used to convert a positive input voltage to a negative output voltage. Typical applications are amplifiers requiring a negative power supply.

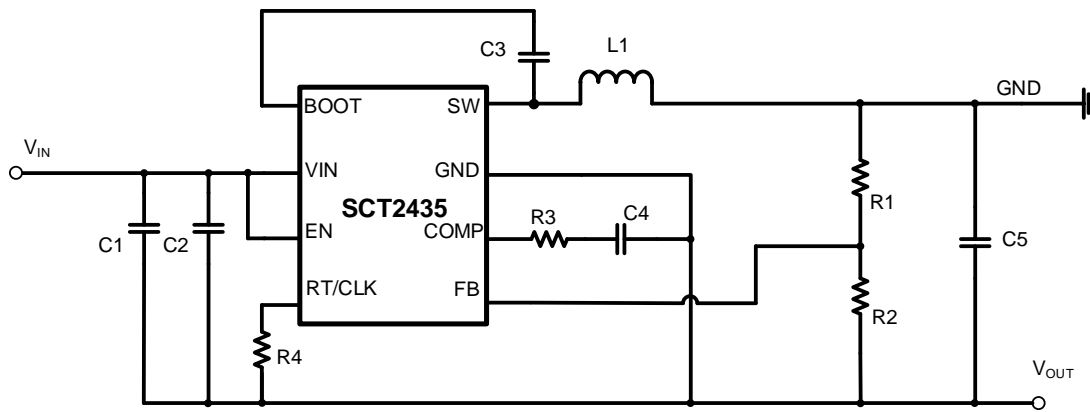

Figure 13. SCT2435 Inverting Power Supply

SCT2435

Application Waveforms

Unless otherwise noted, VIN=24V, VOUT=3.3V, Load=3A, Freq= 500KHz

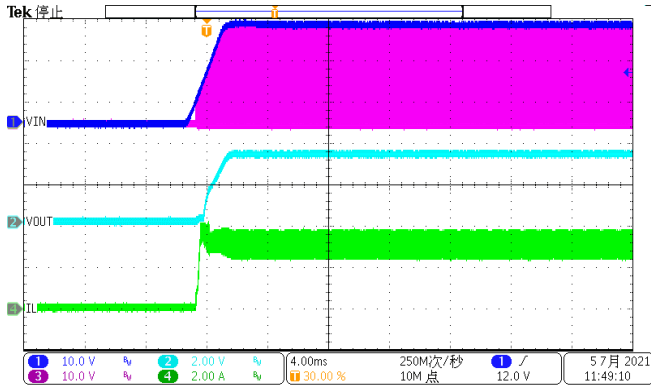

Figure 14. Power up

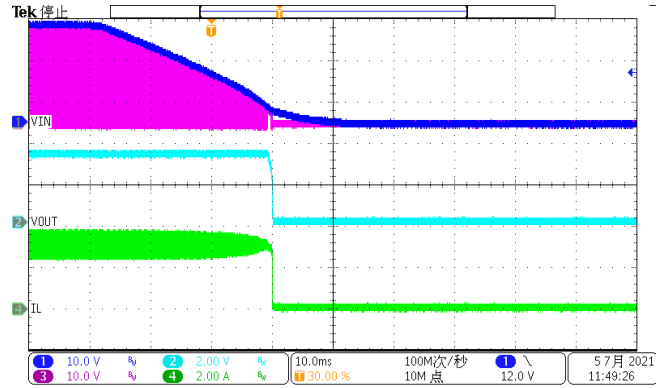

Figure 15. Power down

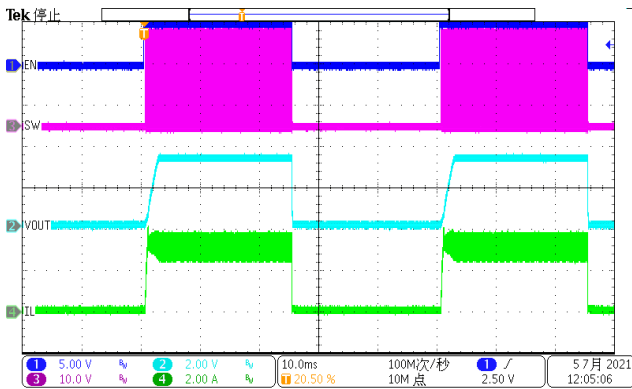

Figure 16. EN toggle (Iload=3A)

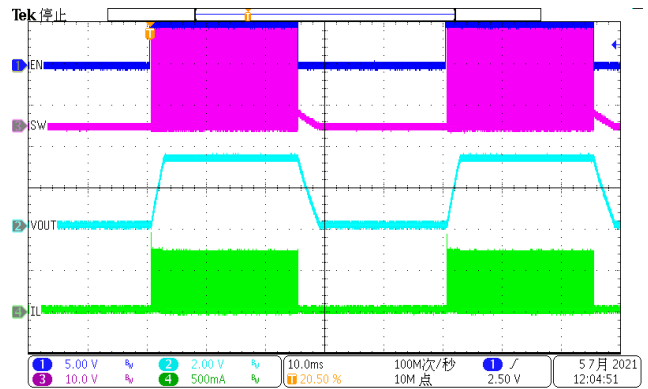

Figure 17. EN toggle (Iload=0.1A)

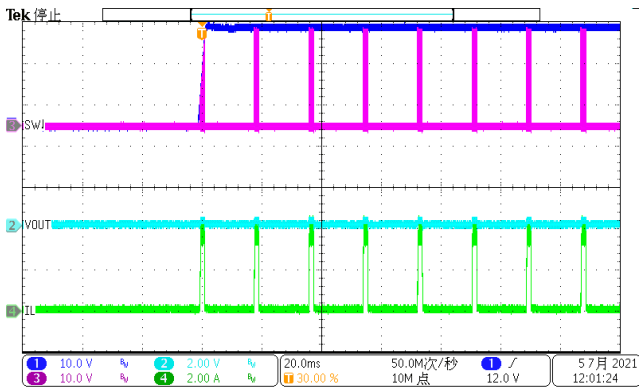

Figure 18. Over Current Protection (poweron to hard short)

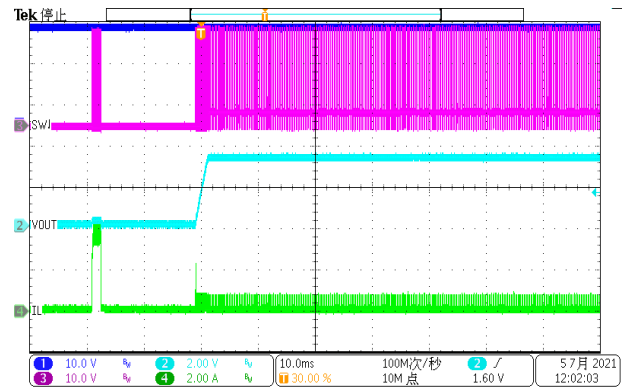

Figure 19. Over Current Release (hard short to 1A)

Application Waveforms (continued)

Unless otherwise noted, VIN=24V, VOUT=3.3V, Load=3A, Freq= 500KHz

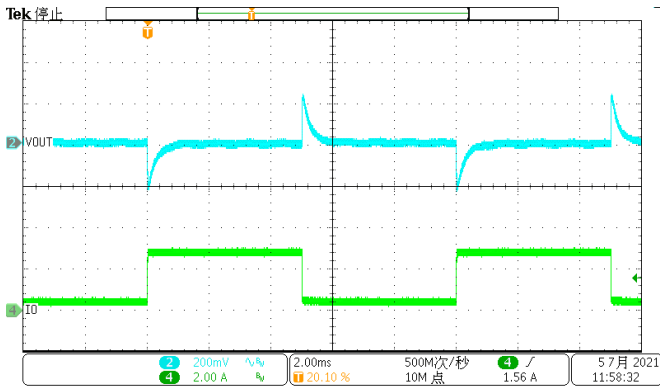

Figure 20. Load Transient (0.3A-2.7A, 1.6A/us)

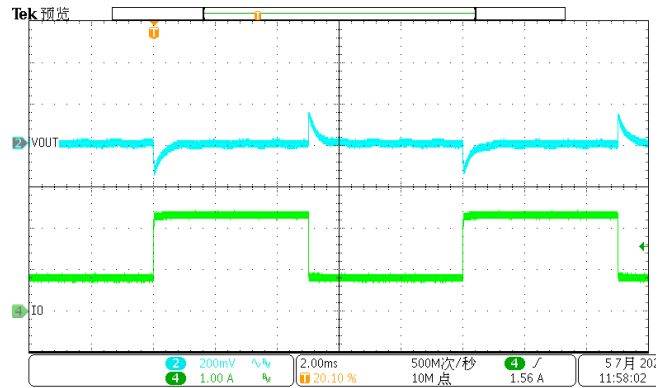

Figure 21. Load Transient (0.75A-2.25A, 1.6A/us)

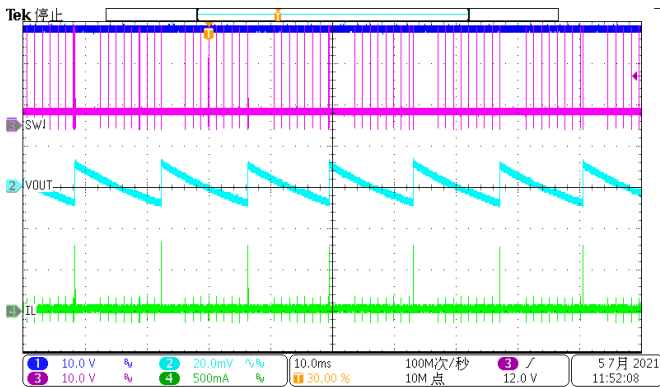

Figure 22. Output Ripple (Iload=0A)

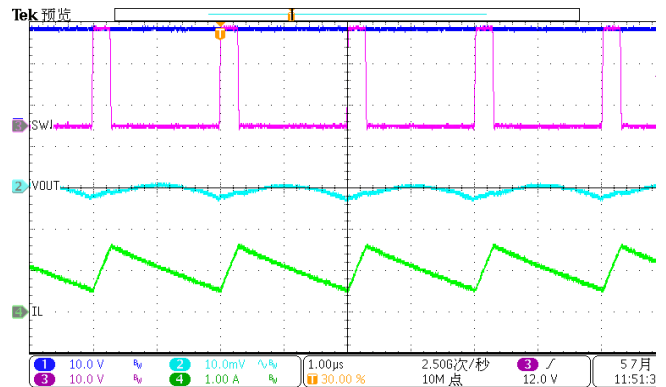

Figure 23. Output Ripple (Iload=1A)

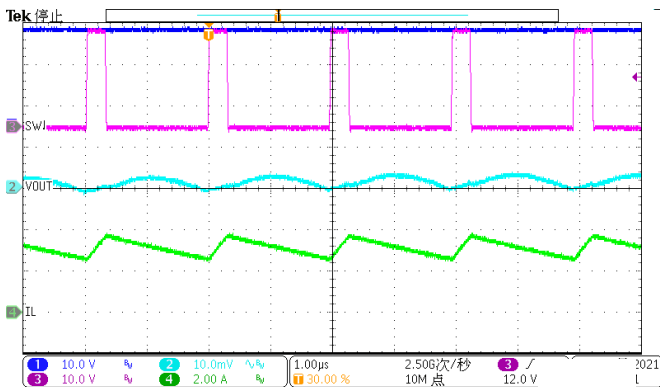

Figure 24. Output Ripple (Iload=3A)

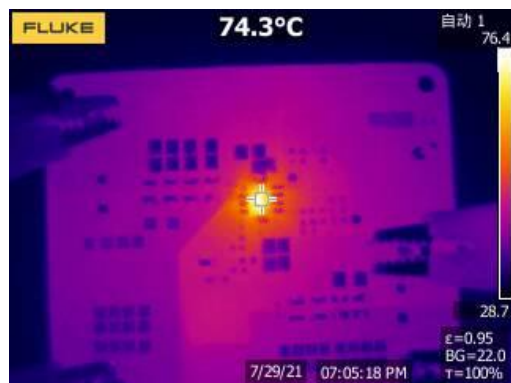

Figure 25. Thermal, 3.3Vout/3A

Layout Guideline

Proper PCB layout is a critical for SCT2435's stable and efficient operation. The traces conducting fast switching currents or voltages are easy to interact with stray inductance and parasitic capacitance to generate noise and degrade performance. For better results, follow these guidelines as below:

1. Power grounding scheme is very critical because of carrying power, thermal, and glitch/bouncing noise associated with clock frequency. The thumb of rule is to make ground trace lowest impedance and power are distributed evenly on PCB. Sufficiently placing ground area will optimize thermal and not causing over heat area.
2. Place a low ESR ceramic capacitor as close to VIN pin and the ground as possible to reduce parasitic effect.
3. For operation at full rated load, the top side ground area must provide adequate heat dissipating area. Make sure top switching loop with power have lower impedance of grounding.
4. The bottom layer is a large ground plane connected to the ground plane on top layer by vias. The power pad should be connected to bottom PCB ground planes using multiple vias directly under the IC. The center thermal pad should always be soldered to the board for mechanical strength and reliability, using multiple thermal vias underneath the thermal pad. Improper soldering thermal pad to ground plate on PCB will cause SW higher ringing and overshoot besides downgrading thermal performance. it is recommended 8mil diameter drill holes of thermal vias, but a smaller via offers less risk of solder volume loss. On applications where solder volume loss thru the vias is of concern, plugging or tenting can be used to achieve a repeatable process.
5. Output inductor should be placed close to the SW pin. The area of the PCB conductor minimized to prevent excessive capacitive coupling.
6. The RT/CLK terminal is sensitive to noise so the RT resistor should be located as close as possible to the IC and routed with minimal lengths of trace.
7. UVLO adjust and RT resistors, loop compensation and feedback components should connect to small signal ground which must return to the GND pin without any interleaving with power ground.
8. Route BOOT capacitor trace on the other layer than top layer to provide wide path for topside ground.
9. For achieving better thermal performance, a four-layer layout is strongly recommended.

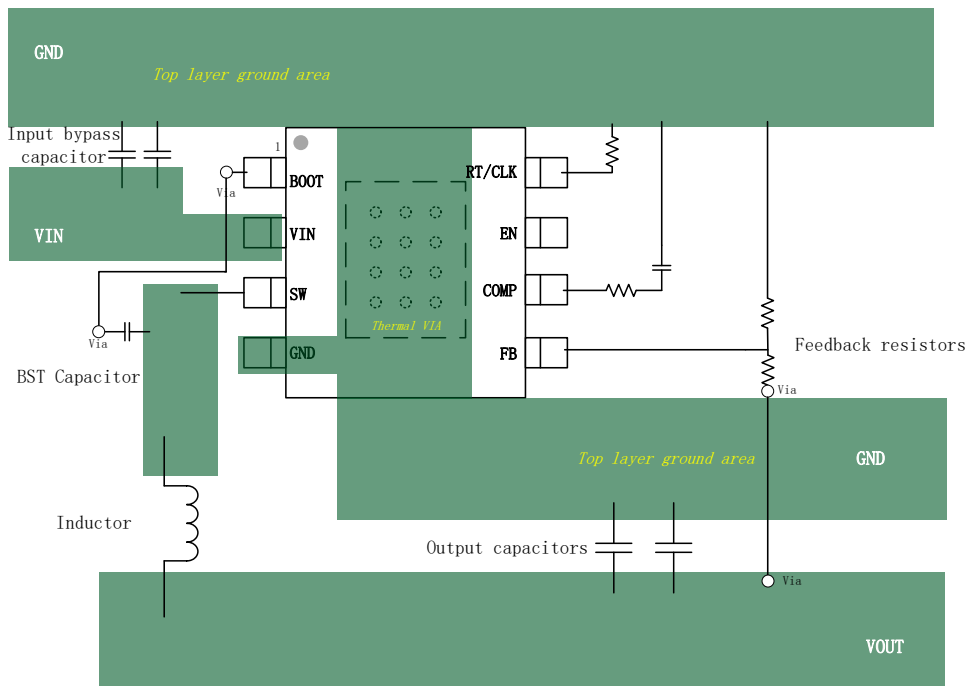
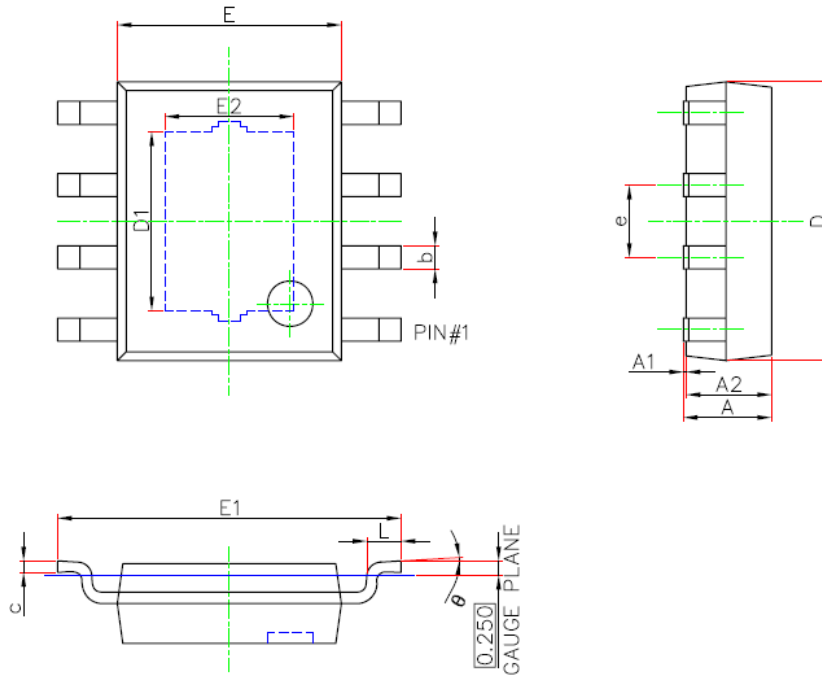

Figure 26. PCB Layout Example

PACKAGE INFORMATION



SOP8/PP(95x130) Package Outline Dimensions

Symbol	Dimensions in Millimeters		Dimensions in Inches	
	Min.	Max.	Min.	Max.
A	1.300	1.700	0.051	0.067
A1	0.000	0.100	0.000	0.004
A2	1.350	1.550	0.053	0.061
b	0.330	0.510	0.013	0.020
c	0.170	0.250	0.007	0.010
D	4.700	5.100	0.185	0.201
D1	3.050	3.250	0.120	0.128
E	3.800	4.000	0.150	0.157
E1	5.800	6.200	0.228	0.244
E2	2.160	2.360	0.085	0.093
e	1.270(BSC)		0.050(BSC)	
L	0.400	1.270	0.016	0.050
theta	0°	8°	0°	8°

NOTE:

1. Drawing proposed to be made a JEDEC package outline MO-220 variation.
2. Drawing not to scale.
3. All linear dimensions are in millimeters.
4. Thermal pad shall be soldered on the board.
5. Dimensions of exposed pad on bottom of package do not include mold flash.
6. Contact PCB board fabrication for minimum solder mask web tolerances between the pins.

SCT2435

TAPE AND REEL INFORMATION

